



King of the Sea
MAREX

Our quality

Your safety and boat pleasure

MAREX
CONGRATULATES YOU
WITH YOUR NEW
320 AFT CABIN CRUISER

You are now the owner of quality product from MAREX. Your boat is built by the highest standards of safety and quality for your safety and pleasure.

The owner's manual is written so that you as a boat owner can have the best possibilities to get experienced with the boat and its functions. The owner's manual contains important information about handling, safety, systems, equipment mounted or delivered with the boat. You will also find useful information about use and maintenance.

It is recommended that you make yourself acquainted with the boats maneuvering ability and properties before you start to use it, regardless of previous boating experience. Your local dealer can assist you in finding an instructor or boating school.

Please study the owner's manual carefully before using the boat.

Producer:

MAREX Boats UAB

Eglių g. 1, Ilgakiemio km., Garliavos sen.,

LT-53288 Kauno r.,

Lithuania

Phone: 00370 37 261 500

Fax: 00370 37 261 700

E-mail: office@marex.lt





Contents

1.0 GENERAL INTRODUCTION.....	4
1.1 INSTALLED EQUIPMENT	6
1.2 SYMBOLS USED IN THE OWNER'S MANUAL	6
1.3 CONSTRUCTION CATEGORIES.....	7
1.4 ABOUT THIS OWNER'S MANUAL.....	8
2.0 TECHNICAL DATA	9
2.1 GENERAL TECHNICAL DATA	9
2.2 HULL	9
2.3 WINDSCREEN.....	11
2.4 ENGINE AND SHAFT	11
2.5 ELECTRIC SYSTEM.....	11
2.6 CAPACITIES	12
3.0 SAFETY	13
3.1 GENERAL	13
3.2 FIRE	14
3.2.1 MANUAL FIRE EXTINGUISHER.....	14
3.2.2 AUTOMATIC FIRE EXTINGUISHER	15
3.2.3 FIRE ALARM	17
3.3 COOKER AND OVEN.....	17
3.3.1 GAS INSTALLATION AND LEAKAGE TEST INSTRUCTION.....	20
3.4 ELECTRIC SYSTEM.....	21
3.5 BATTERIES	22
3.6 ENGINE ROOM	22
3.7 FUEL TANK.....	22
3.8 THROUGH HULL LEADS - UNDER THE WATERLINE.....	24
3.8.1 CLOSING VALVE - SEAWATER INLET FOR THE TOILET SYSTEM.....	24
3.8.2 CLOSING VALVE - BLACKWATER OUTLET.....	24
3.8.3 CLOSING VALVE - SEAWATER INLET FOR ENGINE COOLING	25
3.9 STABILITY AND BUOYANCY	26
3.10 SAFETY EQUIPMENT	27
3.11 EMERGENCY EXITS.....	28
3.12 EMERGENCY STEERING.....	28
4.0 DRAWINGS AND TECHNICAL DESCRIPTIONS OF THE BOAT	29
4.1 ARRANGEMENT AND EXTERIOR DRAWINGS	29
4.2 TECHNICAL SYSTEMS.....	29



MAREX 320 Aft Cabin Cruiser

4.2.1 DRAWINGS OF THE TECHNICAL SYSTEMS	29
4.2.2 PICTURES AND DESCRIPTION OF INSTALLED COMPONENTS.....	30
4.3 FUEL SYSTEM	30
4.4 DRAINING SYSTEM.....	31
4.5 LENSING SYSTEM.....	32
4.5.1 MANUAL LENSING SYSTEM	32
4.5.2 AUTOMATIC LENSING SYSTEM	33
4.6 FRESH WATER SYSTEM	35
4.7 SEPTIC SYSTEM/BLACK WATER SYSTEM.....	37
4.8 ELECTRIC SYSTEM.....	40
4.9 EXHAUST SYSTEM	42
4.10 VENTILATION SYSTEM FOR THE ENGINE	43
4.11 FIRE EXTINGUISHING SYSTEM.....	43
5.0 OPERATION	45
5.1 STARTING OF THE ENGINE	45
5.2 BATTERIES (LEAD ACCUMULATORS)	46
5.3 FUSE PANEL & CONNECTION SCHEMES	48
5.4 MAIN SWITCH PANEL	48
5.5 WINDSCREEN WIPERS	49
5.6 DASHBOARD INSTRUMENTS INSTALLATION ACCESS.....	49
5.7 ELECTRIC SYSTEM.....	50
5.8 SEPTIC SYSTEM	52
5.9 OPERATING OTHER EQUIPMENT	55
5.9.1 COOKER AND OVEN	55
5.9.2 DEFROSTER.....	55
5.9.3 DIESEL HEATER.....	56
5.10 MANOEUVRING OF THE BOAT	57
5.11 HINTS AND ADVICES	60
5.11.1 LIFTING AND STORAGE IN A “CRADLE”	60
5.11.2 BOAT TRANSPORT	61
5.11.3 BOAT MOORING.....	61
5.11.4 BOAT ANCHORING	61
5.11.5 TOWING AND BEING TOWED.....	62
6.0 PERIODIC MAINTENANCE.....	63
6.1 MAINTENANCE OF THE HULL.....	63
6.1.1 BEFORE PLACING THE BOAT ON WATER.....	63
6.1.2 BEFORE WINTER STORAGE	63



MAREX 320 Aft Cabin Cruiser

6.1.3 NORMAL MAINTENANCE	64
6.2 MAINTENANCE OF THE TEAK DECK	64
6.3 MAINTENANCE OF THE ENGINE AND THE DRIVE	64
6.4 MAINTENANCE OF THE STEERING SYSTEM	64
6.5 MAINTENANCE AND CONTROLLING OF THE ELECTRIC SYSTEM	65
6.6 MAINTENANCE OF THE GAS SYSTEM	66
6.7 MAINTENANCE OF THE FUEL SYSTEM.....	67
6.8 MAINTENANCE OF THE LENSING SYSTEM	68
6.9 MAINTENANCE OF THE FIRE EXTINGUISHERS	69
6.10 MAINTENANCE OF THE FRESH WATER TANKS	69
6.11 MAINTENANCE OF THE FENDER LIST	69
7.0 PREPARING FOR THE SEASON.....	70
7.1 GENERAL PREPARATION	70
7.2 PREPARING THE ENGINE AND THE DRIVE	70
7.3 PREPARING THE STEERING	71
7.4 OTHER EQUIPMENT	71
7.5 REMOVING RUST/CORROSION.....	71
8.0 WINTER STORAGE PREPARATION.....	72
8.1 BATTERIES	72
8.2 HULL	72
8.3 STEERING SYSTEM	72
8.4 SEPTIC SYSTEM	73
8.5 FRESHWATER SYSTEM	73
8.6 ENGINE AND DRIVE	73
9.0 ENVIRONMENTAL ISSUES	74
10.0 POSITIONS OF THROUGH HULL AND DECK FITTINGS	75
10.1 STARBOARD SIDE	75
10.2 PORT SIDE	76
10.3 TOP VIEW - HULL BOTTOM.....	77
10.4 TOP VIEW - DECK	78
11.0 OVERVIEW	79
ANNEX 1: A CHECKLIST OF ALL NECESSARY ACTIONS BEFORE USE	80
ANNEX 2: A CHECKLIST OF ALL NECESSARY ACTIONS AFTER THE WINTER STORAGE.....	81



1.0 GENERAL INTRODUCTION

This manual has been compiled to help you to operate your craft with safety and pleasure. It is not a course on boating safety or seamanship. If this is your first boat, or if you are changing to a type of boat you are not familiar with, for your own comfort and safety, please ensure that you obtain handling and operating experience before “assuming command” of the boat.

Ensure that the anticipated wind and sea conditions will correspond to the design category of your boat, and that you and your crew are able to handle the boat in these conditions. Even when your boat is categorized for them, the sea and wind conditions corresponding to the design categories A, B and C range from severe storm conditions for category A, to strong conditions for the top of category C, open to the hazards of a freak wave or gust. These are therefore dangerous conditions, where only a competent, fit and trained crew using a well-maintained boat can satisfactorily operate.

This owner's manual is not a fully detailed maintenance or trouble-shooting guide. In the case of difficulty, refer to the boat builder or his representative.

Always use trained and competent people for maintenance, fixing or modifications. Modifications that may affect the safety characteristics of the boat shall be assessed, executed and documented by competent people. The boat builder cannot be held responsible for modifications that have not been approved.

Always maintain your boat properly and make allowance for the deterioration that will occur in time and as a result of heavy use or misuse of the boat.

Any boat, no matter how strong it may be, can be severely damaged if not used properly. This is not compatible with safe boating. Always adjust the speed and direction of the boat to sea conditions.

The boat should have appropriate safety equipment (lifejackets, harness, etc.) on board according to the type of boat, weather conditions, etc. This equipment is mandatory in some countries. The crew should be familiar with the use of all safety equipment and emergency manoeuvring (man overboard recovery, towing, etc.), sailing schools and clubs regularly organize drill sessions.

All persons should wear a suitable buoyancy aid (life jacket/personal floatation device) when on deck. Note that, in some countries, it is a legal requirement to wear a buoyancy aid that complies with their national regulations at all times.



MAREX 320 Aft Cabin Cruiser

The owner's manual is written according to the following standard:
EN-ISO-10240:2004.

Type: **Marex 320 AFT CABIN CRUISER**

Construction category: **B**

Approval: **EC TYPE EXAMINATION BY DET IMSI (INTERNATIONAL MARINE CERTIFICATION INSTITUTE)**
Certificate number: BMARX001
See copy enclosed in divider number 5.

The boat's CIN number (Craft Identification Number) is engraved aft of the boat, under the fenderlist starboard side.



Picture 1: The boat's CIN number location

PLEASE KEEP THIS MANUAL IN A SECURE PLACE, AND HAND IT OVER TO THE NEW OWNER IF YOU SELL THE BOAT.



1.1 INSTALLED EQUIPMENT

Divider number 4 contains a list of installed equipment in your boat.

1.2 SYMBOLS USED IN THE OWNER'S MANUAL

DANGER:

The “Danger” warnings in the owner’s manual or in the installed component **MUST** be followed to avoid personal injury or serious material damage.

WARNING:

The warnings must be followed to avoid damage on boat or on equipment.

CAUTION:

This should be remembered to avoid damage on persons or equipment.

DESCRIPTION:

This is the description of location of the equipment or component.

INSTRUCTION MANUAL:

Read the separate instruction manual/user manual for this equipment. This is placed in the “User bag” enclosed in the boat.



1.3 CONSTRUCTION CATEGORIES

EU-directive 94/25/EC defines the following construction categories:

A. OCEAN: This craft is designed for extended voyages where conditions may exceed wind force 8 (Beaufort scale) and significant wave heights of 4 m and above but excluding abnormal conditions, and vessels largely self-sufficient.

B. OFFSHORE: This craft is designed to operate in winds up to Beaufort force 8 and the associated wave heights (significant wave height up to 4 m). Such conditions may be encountered on offshore voyages of sufficient length, or on coastal waters when unsheltered from the wind and waves for several dozens of nautical miles. These conditions may also be experienced on inland seas of sufficient size for the wave height to be generated.

C. INSHORE: This craft is designed to operate in winds up to Beaufort force 6 and the associated wave heights (significant wave height up to 2 m). Such conditions may be encountered in exposed inland waters, in estuaries, and in coastal waters in moderate weather conditions.

D. SHELTERED WATERS: This craft is designed for voyages on sheltered coastal waters, small bays, small lakes, rivers and canals when conditions up to, and including, wind force 4 and significant wave heights up to, and including, 0,3 m may be experienced, with occasional waves of 0,5 m maximum height, for example from passing vessels.

Boats in each category must be designed and constructed to withstand these parameters in respect of stability, buoyancy, and other relevant essential requirements, and to have good handling characteristics.

CAUTION:

**THE ACTUAL USE OF THE BOAT IS ON OWN RISK. READ ALL THE WARNINGS
IN THE OWNER'S MANUAL.**



1.4 ABOUT THIS OWNER'S MANUAL

- ✓ This owner's manual is a part of the documentation that follows the boat.
- ✓ Included in the boat is a "user bag" that contains the owner's manual and separate instructions.



Picture 2: The user bag

- ✓ This "user bag" is considered a part of the boat and must be included in the boat for future owners.
- ✓ Marex is continuously developing the quality of its products. This owner's manual contains information updated at the time of the print of this book and may therefore deviate from your boat. Please contact Marex or your local dealer if questions regarding the owner manual appear.
- ✓ This owner's manual is adjusted to a standard equipped boat.
- ✓ Many Marex boats are custom made. Equipment that is not of significant importance to the safety or stability of the boat is not incorporated in this owner's manual.



2.0 TECHNICAL DATA

Part of the information is given on the builder's plate fixed on the craft. A full explanation of this information is given in the relevant sections of this manual.

2.1 GENERAL TECHNICAL DATA

Boat type: **Marex 320 AFT CABIN CRUISER**
Construction category: **B**

2.2 HULL

Type	Measurement	Unit
Length over all, including bowsprit and platform (LOA)	10.46	m
Length hull waterline (LWL)	7.82	m*
Transport height without lantern mast and mounted extra equipment (Transport height excluding the rudder and propeller)	3.60	m*
Transport height without lantern mast and mounted extra equipment (Transport height including the rudder, propeller and propeller protector)	3.94	m
Total height from bottom to top lantern mast, including flagpole	4.38	m*
Height from the waterline (Sailing height) with lantern mast, including flagpole	3.70	m*
Height from the waterline (Sailing height) with lantern mast, excluding flagpole	2.91	m*
Height from the hulls keel to the top of the lantern mast, including top lantern	4.38	m
Height of the mounted and removable lantern mast	0.78	m
Marex cradle height	0.10	m
Beam excluding fender list BOA	3.30	m
Beam including fender list BOA	3.37	m
Beam of the boat waterline BWL	2.86	m
Displacement of empty boat single engine	5000	kg *
Maximum recommended load**	6750	kg
Maximum allowed load***	7000	kg

- m*/ kg* standard boat and weight according to single Volvo D4-300
- ** Maximum recommended load includes the weight of all persons onboard, all provisions and personal effects, any equipment not included in the light craft mass, cargo (if any) and all consumable liquids (water, fuel, etc.).
- *** see section 2.5 Capacities



MAREX 320 Aft Cabin Cruiser

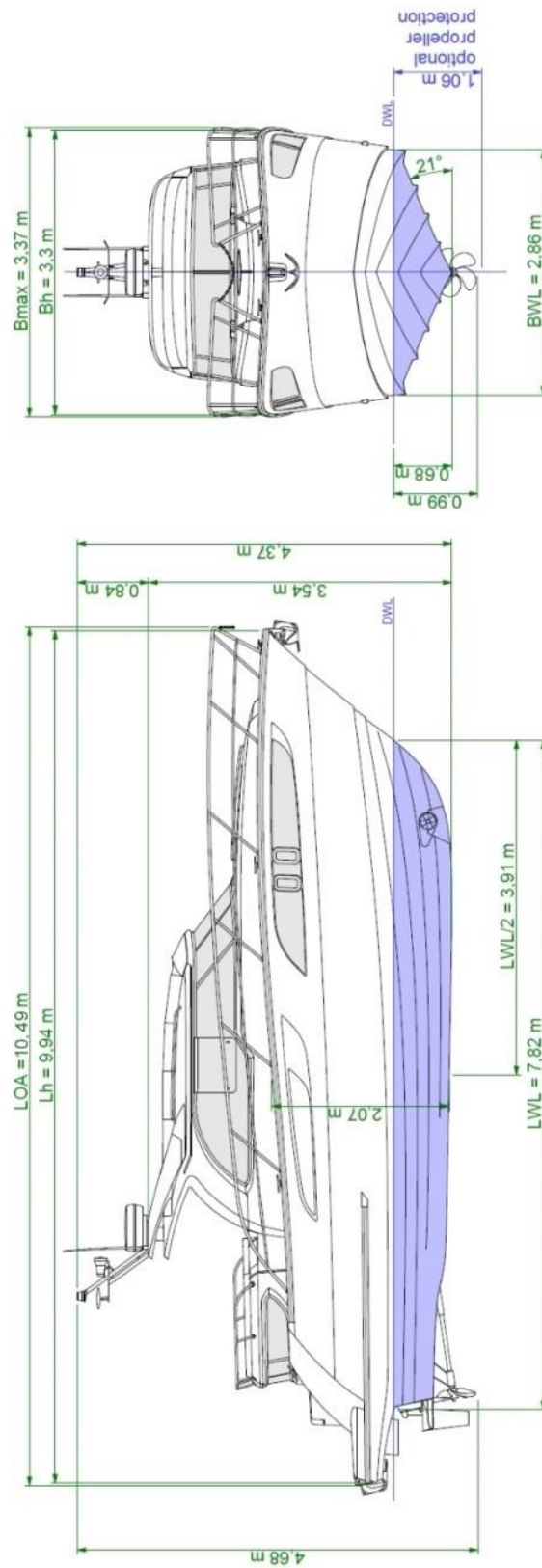

Figure 1: Main dimensions



MAREX 320 Aft Cabin Cruiser

2.3 WINDSCREEN

Defects allowed:

1. Scratches up to 30 mm in length, no more than 1 pcs on one glass.
2. Damages smaller than 0.5mm, no more than 3 pcs on one glass.
3. Damages smaller than 2mm in diameter, within 30 mm of the edge. No more than 3pcs on one glass.

2.4 ENGINE AND SHAFT

Engine type: **Marine diesel, single shaft**

Single engine: **221kW (300Hp) 370Hp max**

2.5 ELECTRIC SYSTEM

Voltage: **12V DC & 230V AC**

Starter battery: **100 Ah**

Service batteries: **3 X 90 Ah**

**Optional: AGM battery start 1x92 Ah,
service 4x90 Ah**



2.6 CAPACITIES

Fuel tank:	480 litres* (All of its capacity may not be usable according to trim and loading and 20% reserve should be kept.)
Water tank:	320 litres* - 2 x 160 litres (All of its capacity may not be usable according to trim and loading.)
Septic tank:	160 litres*
Lens pump – manual: Engine room: Front cabin:	23.6 L/min 23.6 L/min
Lens pump – electric: Engine room: Front cabin (optional):	54.25 L/min 54.25 L/min
Max load incl. 8 persons (adults), full tanks and luggage:	1950 kg
Max load incl. 8 persons (adults) and luggage (as shown on the producer plate):	850 kg
Max recommended number of persons:	8 persons (adults)

* Total weight of liquids (fuel tank, water tank and septic tank), when all permanently installed tanks are full, is 900 litres.

WARNING:

Do not exceed the maximum recommended number of persons. Regardless of the number of persons on board, the total weight of persons and equipment must never exceed the maximum recommended load. Always use the seats/seating spaces provided.

WARNING:

When loading the craft, never exceed the maximum recommended load. Always load the craft carefully and distribute loads appropriately to maintain design trim (approximately level). Avoid placing heavy weights high up.



3.0 SAFETY

We summarize the important information for safety aboard. A great deal of the information will be repeated later in the owner's manual, but Marex signify the importance for you as a customer and user of the boat that this information must be easily accessible in a stressed situation.

What is described here should be carefully studied by the user.

3.1 GENERAL

WARNING:

Never:

- ✓ let objects block the emergency exits (doors and hatches).
- ✓ let objects hinder access to the fuel stop valve, lens pumps and electrical switches.
- ✓ let objects hinder access to fire extinguishers.
- ✓ use gas lights.
- ✓ change any of the boats technical systems – especially the gas fuel and electrical systems.
- ✓ fill the fuel tank while the engine is running or while the cooker or heater is in use.
- ✓ smoke when handling fuel.
- ✓ use the rails to pull anything after the boat.
- ✓ use the rails as mooring.
- ✓ place fenders at the exhaust outlets for heater and cooker.

Always:

- ✓ inspect the whole boat, particularly the engine room for leakages before every start-up of the engine.
- ✓ have cabin doors closed during sailing. The weight of the doors can make the doors slam. Also close all port lights and windows during rough weather conditions or while planning.
- ✓ hold lensing pump free from impurities.
- ✓ check for leakage of the fuel system.
- ✓ check the fuel level.



3.2 FIRE

⚠ DANGER:

📖 INSTRUCTION MANUAL

- Portable fire extinguisher (2 kg, type ABE class II - powder apparatus) is located inside the trash closet in the pantry.
- The engine room has an automatic fire extinguisher system with auto discharge and auto stop of the engine. This extinguisher has an indicator located by the dashboard.

⚠ WARNING:

- Do not mount curtains or other fabrics over or close to any cooker or open flame sources. It is prohibited to store flammable material in the engine room! If non-flammable material is kept in the engine room it must not block access or risk contact with hot engine parts.
- Do not store equipment containing petrol (outboard engines, tanks, petrol generators, etc.) in compartments that are not designed for this purpose.

When fire gets out of control, you have to:

- take on the emergency vests.
- send emergency signals by radio or chart plotter, signal lights or telephone.
- evacuate the boat.

3.2.1 MANUAL FIRE EXTINGUISHER

📖 INSTRUCTION MANUAL

See the separate manual in the “user bag”. Read the instructions at the apparatus and be prepared for an emergency.

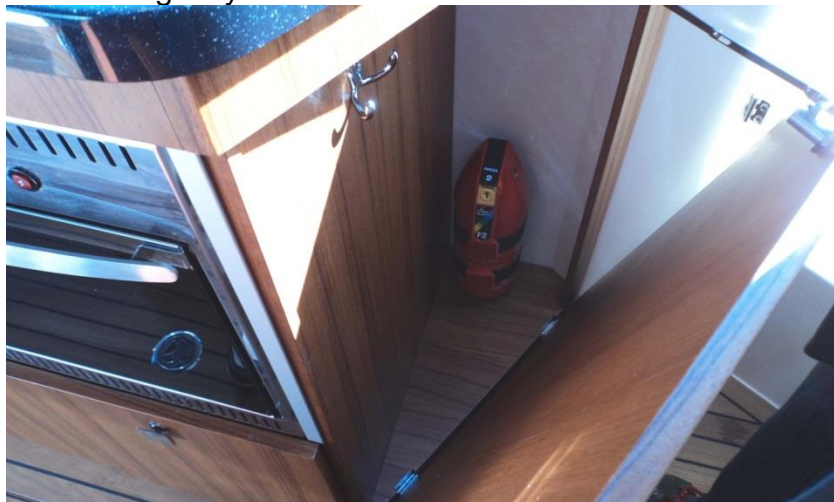

Picture 3: Location of the manual fire extinguisher



MAREX 320 Aft Cabin Cruiser

⚠ WARNING:

- Do not lift or transport the extinguisher holding the sensor valve.
- Do not drop the extinguisher.
- Keep the extinguisher out of reach from the children.
- After a discharge – REPLACE the extinguisher.

📖 INSTRUCTION MANUAL

All fire extinguishers must be controlled one time per year by qualified personnel.

The user/owner is responsible for:

- That the extinguisher is controlled by qualified personnel at recommended times.
- That the extinguisher is replaced with working equipment.
- Inform the passengers about:
 - ✓ the location and use of the fire extinguisher.
 - ✓ the location of the emergency exits.
- Assure that fire extinguisher is easily accessible.

3.2.2 AUTOMATIC FIRE EXTINGUISHER

📖 INSTRUCTION MANUAL

Read the manual for Sea-Fire, enclosed in the “user bag”.

Boat with engine(s) larger than 120 kW (163 Hp) is equipped with a permanent fire extinguisher in the engine room.



Picture 4: Automatic fire extinguishing system in the engine room (1), fire extinguisher volume level (2)



MAREX 320 Aft Cabin Cruiser

The fire extinguisher in the engine room automatically discharges by temperatures over 74° C. Indicator by the helmsman's position informs if the extinguisher has been discharged. When automatic discharge of the content happens, the engine stops automatically!



Picture 5: Fire extinguisher indicator

When the ignition is on, the lamp indicator will light as long as the system is ready to be discharged. After a discharge the lamp will no longer light.

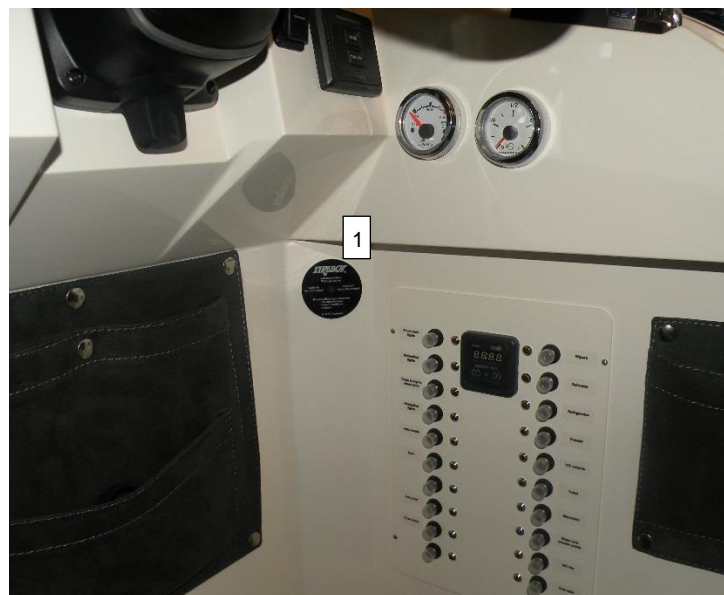

Picture 6: The fire extinguisher lamp indicator on the dashboard (1)

⚠ CAUTION

Your boat has an automatic fire extinguishing system in the engine room that uses FM200 as an active component.



PROCEDURE WHEN AUTOMATIC DISCHARGE HAPPENS:

- When automatic discharge of the content happens, you have to turn off the main switches.
- Then evacuate the cabins.
- Let the automatic extinguisher in the engine room work for several minutes.
- Grab the manual fire extinguisher and release the safety pin.
- **After discharge always ventilate before entering the engine room. When you open the engine hatches, have the manual extinguisher ready and be alert.**
- Control the engine room for remaining fire.

⚠ DANGER:

The engine room has a non-removable installed system. The content can cause serious respiration problems and be fatal.

3.2.3 FIRE ALARM

Marex is one of few producers that mount a fire alarm as standard equipment. We prioritize your safety and have mounted one alarm in the ceiling of the front cabin. This must be tested regularly.

3.3 COOKER AND OVEN

Standard equipment includes a gas cooker.

📖 INSTRUCTION MANUAL

- Read user manuals and installation instructions.

⚠ DANGER:

Remember that the cooker uses oxygen to burn!

⚠ WARNING:

- **The cooker must not be used as a heating oven.**
- **Never leave the boat with gas devices in use.**
- **Never start the cooker without checking the system.**

⚠ CAUTION

- Avoid contact of materials with naked flames and other hot areas.
- Do not use detergents containing ammoniac.



MAREX 320 Aft Cabin Cruiser

- The gas bottle is located in the bathing platform bench storage. The compartment where the gas bottle is kept is drained out under the bathing ladder cover.



Picture 7: Gas bottle - the pressure reduction valve (1)

The pressure reduction valve must never come in contact with saltwater; when it does, it will start to corrode. If any corrosion is seen it must be changed before you use the gas system. The pressure reduction valve must be controlled often and should be replaced every year.



Picture 8: Gas closing valve for cooker and oven (1) is inside of the trash closet in the pantry



MAREX 320 Aft Cabin Cruiser

➤ **If the gas cooker is installed:**

- ✓ Close the closing valves to the cooker and the valve in the compartment on the bathing platform when the cooker is not in use.
- ✓ Close the valves before changing the gas bottles.
- ✓ Close the valves immediately in an emergency.
- ✓ Make sure that the valves are closed before opening the safety cap on the bottle.

- **Do not block the access to any components of the gas system.**
- Keep the valves for empty gas bottles closed and disconnected. Keep hatches closed and all plugs in place. Store the spare gas bottle in ventilated rooms or in a gas tight container with certified ventilation.
- Never use the gas boxes for storing of other equipment.
- Do not use the gas system if the boat is not in balance.

⚠ WARNING:

Fuel burning devices with open flame consume oxygen in the cabin and release products of combustion into the boat. Ventilation is required when gas appliances are in use. Open designated venting openings while gas appliances are in use. Never obstruct ventilation openings and ensure that gas appliances are operating correctly.



3.3.1 GAS INSTALLATION AND LEAKAGE TEST INSTRUCTION

⚠ DANGER:

⚠ WARNING:

❖ SAFETY

The pressure gauge is designed to check current pressure in system and can be used to detect leaks in gas systems with a maximum working pressure of **200 kPa (2 bar)**. The system is supposed to be checked prior to the first use, after a period of non-use and every time the gas bottle is changed.

Propane is an explosive gas; therefore, smoking and open flames are absolutely prohibited.

❖ TESTING

With a gauge fitted:

1. Close appliance valve,
2. Open LPG cylinder valve,
3. Allow indicated gauge pressure to stabilize,
4. Close LPG cylinder valve,
5. Observe pressure gauge reading for 3 min, pressure gauge reading should remain constant if no leak in the LPG system is present.

The gauge does not provide an indication of liquid LPG remaining in the cylinder, only its vapour pressure, which is a constant at any given temperature.

⚠ WARNING:

Do not use an installation that has leaked until it has been inspected and repaired by a competent person.



3.4 ELECTRIC SYSTEM

⚠ DANGER:

Never:

- ✓ work on the electrical system when the system is activated.
- ✓ change the electric installation and relevant parts. Use an authorized marine electric technician.
- ✓ change or divert the power circuits or fuses.
- ✓ install or replace electrical components with higher voltage than the system permits.
- ✓ leave the boat without attention with the electrical system activated except for the systems for the automatic lens pump, the fire protection and the alarm.
- ✓ use start-cables without spark protection/ignition protection. This can damage the electronic system for the engine!

⚠ DANGER:

To minimize the danger of shock and fire:

- ✓ **Turn off the switch to the shore connection in the boat before any connection or disconnection of the cable power.**
- ✓ **Always connect**/plug the boat first and then the electric circuit on land.
- ✓ **Always disconnect**/unplug on land and then on the boat.
- ✓ Make sure that the cover of the plug is in use.
- ✓ Do not change the connections in the systems.
- ✓ Use only certified cables.
- ✓ Use grounding cables (green or green with yellow stripe) on metal covers on the 230V electric equipment.



⚠ DANGER:

Do not let the shore-connection cable fall into the water. This can cause DAMAGE AND DEATH! An electric field can be created and is a danger to life!

⚠ DANGER:

If a shore connection is fitted, do not swim close to the boat.

3.5 BATTERIES

⚠ WARNING:

By charging the batteries an explosive gas develops. Do not use open flame close to the batteries when charging them. The smell of rotten eggs is a clear indicator of a leakage.

3.6 ENGINE ROOM

⚠ WARNING:

- **Do not enter the engine room when the engine is running.**
- **Stop the engine for inspection of propeller.**
- **Do not operate the boat with an engine of rated power greater than the maximum recommended power.**

3.7 FUEL TANK

Fuel tank is placed in the engine compartment (under the cockpit floor).

The emergency closing valve for the engine fuel feed is located in the main switch panel (sitting group).



Picture 9: Emergency engine fuel closing valve and extinguisher with engine stop – sitting group (1)

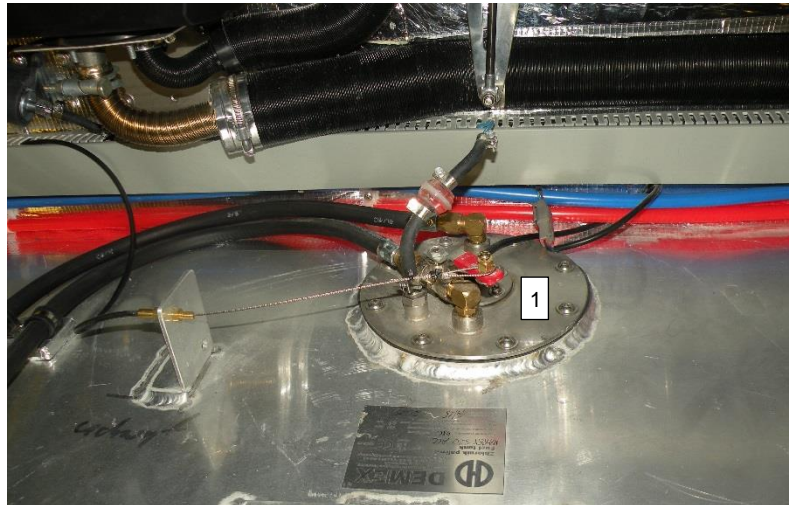

Picture 10: Emergency engine fuel closing valve – engine room (1)

⚠ WARNING:

When the valve handle is a cross the hose, then it is closed (Figure 11).
When the valve handle is placed parallel with the hose, then it is open (Figure 11).

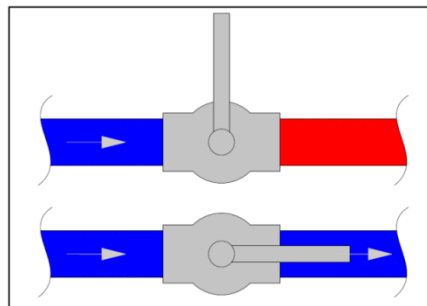

Figure 11

⚠ CAUTION

Make sure that the fuel lines are always intact. The pipe should not be extremely bended, close to corners or any other sharp areas.

- Exit the boat for filling fuel.
- Do not overfill the tank. Carefully measure the proper amount of diesel when refuelling. Leave some space in the tank to avoid spillage during normal motion of the boat.
- When refuelling, check if the fuel line has an automatic stopping device.
- Ensure that no fuel is discharged over the side or into any part of the boat.
- Regularly check that all fuel line connectors are tight.

(F) DANGER

When refuelling the tank, do not smoke. It is dangerous.



3.8 THROUGH HULL LEADS - UNDER THE WATERLINE

3.8.1 CLOSING VALVE – SEAWATER INLET FOR THE TOILET SYSTEM

The seawater inlet closing valve for the automatic toilet (optional) is placed under the hallway floor in the front cabin area.



Picture 11: Location of the seawater inlet for the toilet flush (1)

⚠ DANGER:

Close the septic tank outlet **BEFORE** cleaning the seawater filter for the toilet.

3.8.2 CLOSING VALVE – BLACKWATER OUTLET

The closing valve for blackwater outlet is placed under the cockpit floor in the engine room.

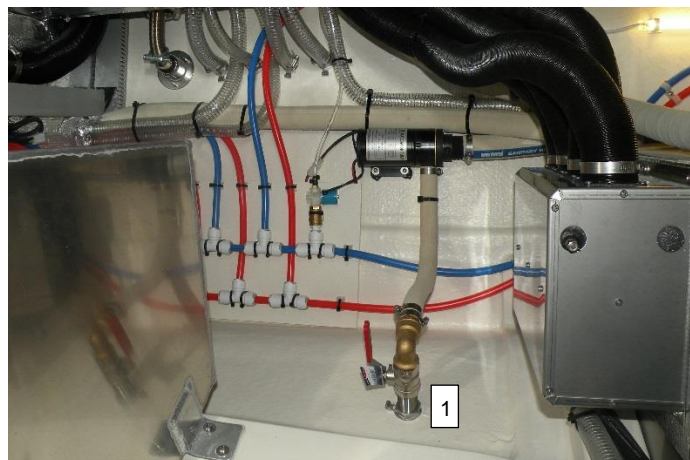

Picture 12: Location of the black water outlet and valve (1)



MAREX 320 Aft Cabin Cruiser

⚠ WARNING:

When the valve handle is across the hose, then it is closed (Figure 12).

When the valve handle is placed parallel with the hose, then it is open (Figure 12).

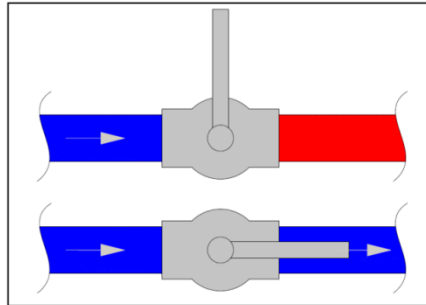

Figure 12

⚠ WARNING:

Check frequently for leakage. Do not leave the valve open without regular controls. It is advisable to keep the unused valves closed at all times, for prevention of eventual flooding.

3.8.3 CLOSING VALVE – SEAWATER INLET FOR ENGINE COOLING

The seawater inlet closing valve is placed under the cockpit floor in the engine room.



Picture 14: Location of seawater inlet for engine cooling and valve (1)



3.9 STABILITY AND BUOYANCY

For the stability of the boat it is important:

- not to exceed provided number of persons.
- to consider maximum total load of the boat.
- not to change position of the masses (for example the radar, engine, tanks, batteries, etc.). This may significantly affect the stability and performance of the boat.
- that all standard equipment is aboard.
- to remove collected bilge water (it should be kept to a minimum).
- not to add any weight on to higher boat areas.
- to consider the design/construction category.
- to close all hatches, lockers and doorways to minimize the risk of flooding.
- not to tow or lift heavy objects using a davit or the boom.



3.10 SAFETY EQUIPMENT

⚠ DANGER:

- In most countries safety vests or something similar must be available for ALL passengers aboard. All of them should also know how to use such equipment.
- A Life raft canister can be placed at the bathing platform by the aft bench.
- **Rehearse on “Man overboard” and practice the easiest boarding of the boat from the water. This can save your and your family’s life.**
 - Man overboard is a situation in which a person has fallen from a boat or ship into the water and is in need of rescue.
 - Falling overboard is one of the most dangerous and life-threatening things that can happen at sea. Therefore it is really important that every person on a boat has his/her own safety vest that has been adjusted to fit him/her before leaving port.
 - Whoever sees the person's fall should shout "man overboard" to alert other crew members and attempt to maintain visual contact with the person in the water. By pointing continuously at the victim, the person can help the helmsman in approaching the victim.
 - The answer to a man overboard is never for more people either to jump over to 'help' him/her, or to fall in themselves by accident.
 - The helmsman must stop the boat immediately and try to approach the person in the water.
 - **Re-boarding of the victim can be done with use of the bathing ladder. The hatch opens into vertical position so that the bathing ladder is accessible. Flip the ladder into the water and close the hatch (see Picture 15).**



Picture 15: Bathing platform with open ladder cover



3.11 EMERGENCY EXITS

⚠ DANGER:

Emergency exits front cabin:

- ✓ Door from front cabin to the cockpit opening size 53 cm.
- ✓ Hatch in front cabin roof opening diameter 46 cm.

Emergency exit aft-cabin:

- ✓ Door from aft-cabin to the cockpit opening size 55 cm.

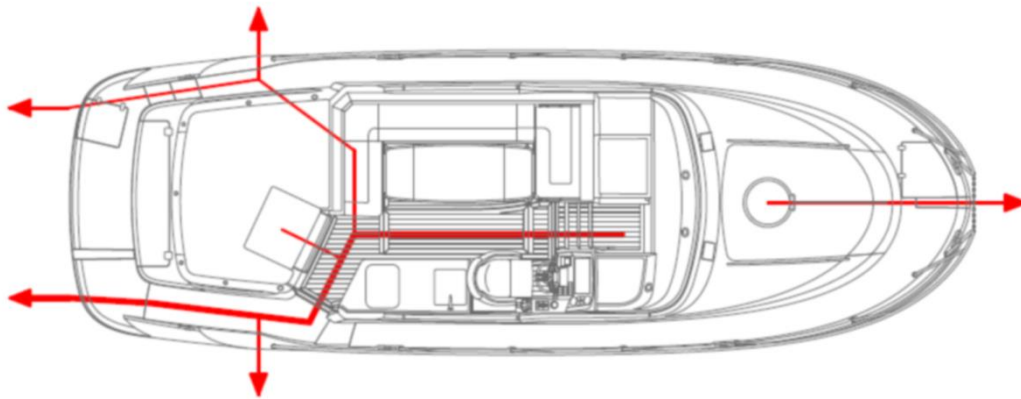

Figure 13: The emergency exit routes

3.12 EMERGENCY STEERING

EMERGENCY STEERING is possible with the use of bow and stern thruster. It is also possible to manually operate the rudder from within the aft cabin (only in case of power steering failure). Under the foldable table is a hatch for rudder access. A long rod must be attached to the rudder, while the hydraulic cylinder has to be detached.

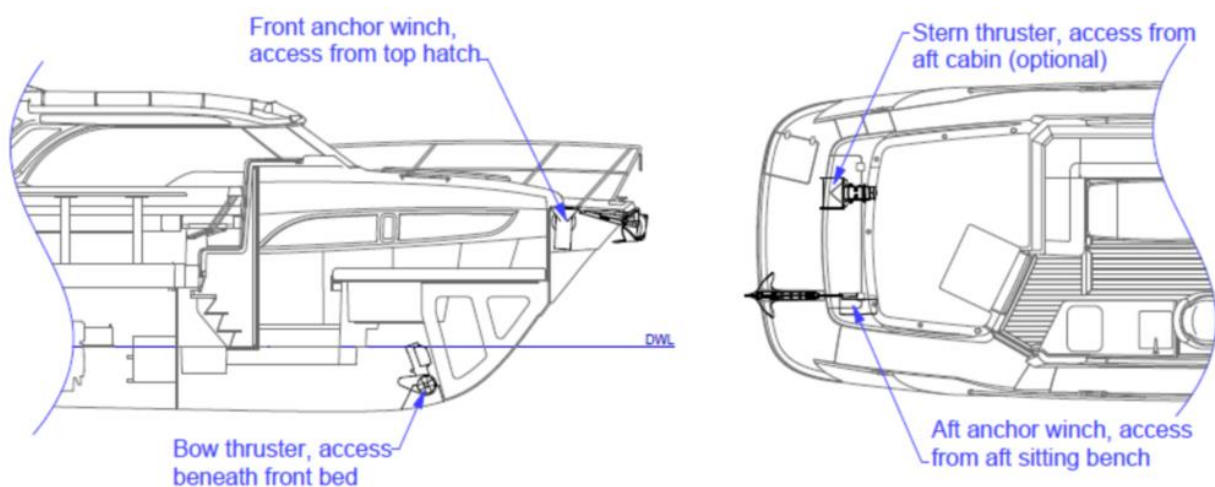

Figure 14: Emergency steering



4.0 DRAWINGS AND TECHNICAL DESCRIPTIONS OF THE BOAT

↗ These drawings show a standard boat.

4.1 ARRANGEMENT AND EXTERIOR DRAWINGS

Divider number 2 includes the following drawings:

- UM-01 Main particulars
- UM-02 General arrangement - Interior – Port side
- UM-03 General arrangement - Interior - Starboard
- UM-04 General arrangement - Interior - Top view
- UM-05 General arrangement - Exterior - Top view

4.2 TECHNICAL SYSTEMS

4.2.1 DRAWINGS OF THE TECHNICAL SYSTEMS

Divider number 4 includes the following drawings:

- UM-06 Trough hull fittings - Top
- UM-07 Trough hull fittings - Starboard
- UM-08 Trough hull fittings – Portside
- UM-09 Deck trough fittings
- UM-10 Access hatches
- UM-11 Emergency exit routes
- UM-12 Engine room ventilation
- UM-13 Fuel system – 1 diesel engine
- UM-14 Water system
- UM-15 Septic system (WC/Pump system)
- UM-16 Draining and lensing systems
- UM-17 Heating and defroster system
- UM-18 Fire extinguishers
- UM-19 Principal drawing 12V system
- UM-20 Principal drawing 230V system
- UM-21.1 Main switch panel – Navix version
- UM-21.2 Main switch panel – Retronic version
- UM-22.1 Fuse panel – Navix version
- UM-22.2 Fuse panel – Retronic version
- UM-23 Illumination
- UM-24 Steering wheel scheme
- UM-25 Anchor winches and side thrusters
- UM-26 Mooring and towing
- UM-27 Lifting points



4.2.2 PICTURES AND DESCRIPTION OF INSTALLED COMPONENTS

In divider number 7 in this owner's manual you will find pictures with descriptions of installed components in a standard Marex 320 Aft Cabin Cruiser.

4.3 FUEL SYSTEM

The fuel system consists of one fuel tank in the engine compartment (placed under the cockpit floor) and hoses connected to the tank shown on the enclosed drawings. The tank is made of stainless steel sheet metal. For maintenance and control of this system, please contact a marine service workshop.

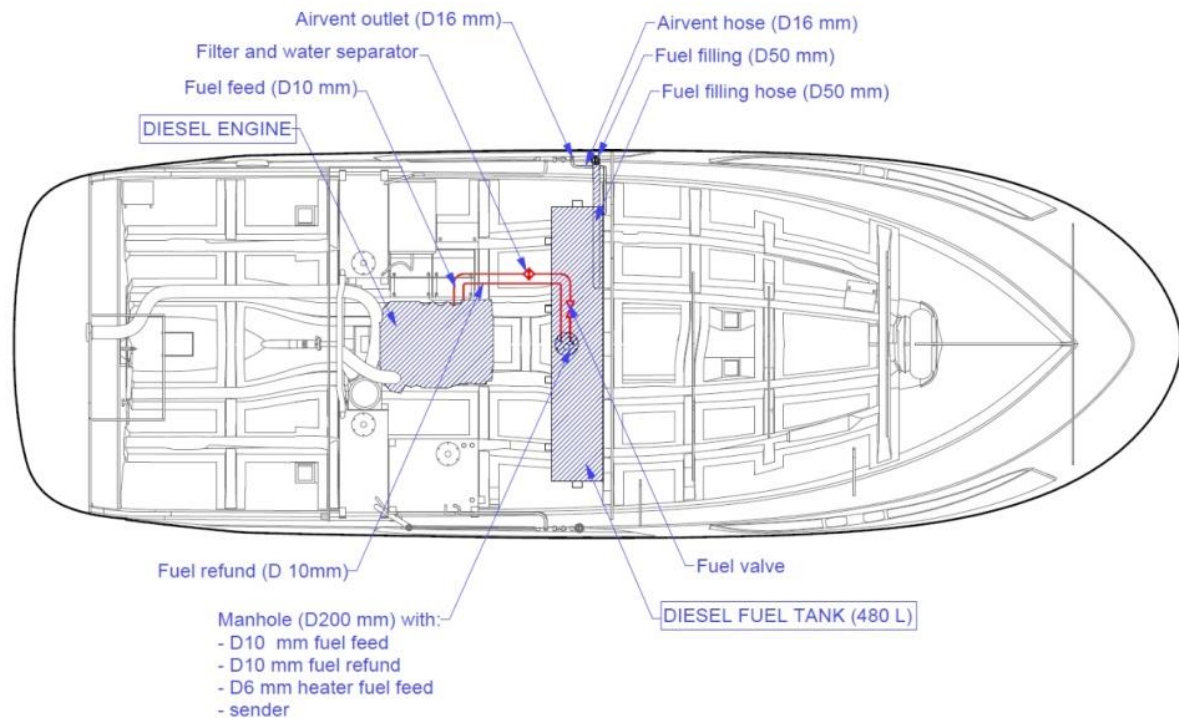
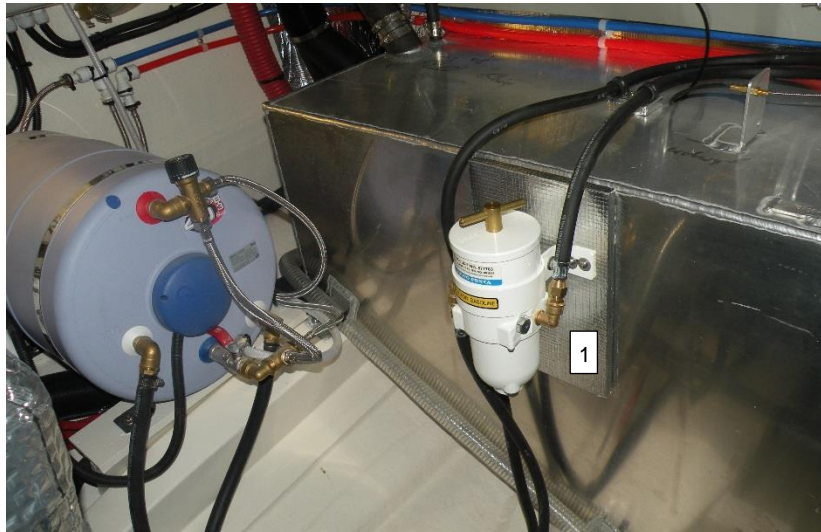

Figure 15: The fuel system (top view)

Fuel closing valve is mounted above the fuel tank, and there is also an emergency valve, located in the main switch panel (sitting group).

Filter/water separator in the engine room must be checked on a regular basis. If any impurities or water is discovered in the separator, you need to contact the service workshop.



Picture 16: The diesel filter with water separator (1)

Possible errors:

- blocked tank ventilation
- closed position of the fuel valve
- the fuel filter is full of water
- the fuel filter (“fine filter”) is full, 📖 read the user manual for the engine
- defected fuel pump on the engine
- objects in the tank that can block the internal flow

4.4 DRAINING SYSTEM

Draining of the cockpit floor:

- The starboard cockpit drain is located in the front corner of the engine hatch canal. It leads out through the hull on the starboard side.



Picture 17: Cockpit drain in the engine hatch canal – starboard side (1)



MAREX 320 Aft Cabin Cruiser

- The port side drain is located in the aft back corner of the engine hatch canal and leads out on the portside through hull fitting.



Picture 18: Cockpit drain in the engine hatch canal – port side (1)

4.5 LENSING SYSTEM

⚠ WARNING:

The bilge pumping system is not designed for damage control.

4.5.1 MANUAL LENSING SYSTEM

The boat has two manual lens pumps:

- One is placed under the hallway floor in the front cabin area (front area).
- Second manual pump is placed under the sitting group bench (engine room).



Picture 19: Location of the manual lensing pump in the front cabin area (1)



MAREX 320 Aft Cabin Cruiser



Picture 20: Location of the second manual pump (1)
(under the sitting group bench)

The manual lensing system pumps out the water by hand. This system is standard and is operable from within the designated area. **Stick the “pin” (a steel rod with a black handgrip) and pump up and down.** The lens pump is pumping water out of the room in the direction of the pointed arrow.

4.5.2 AUTOMATIC LENSING SYSTEM

⚠ WARNING:

Automatic lens pump does not replace a visual control and it does not work if the batteries have a lower voltage than 11 Volts.

- The automatic lensing system works only for the engine room

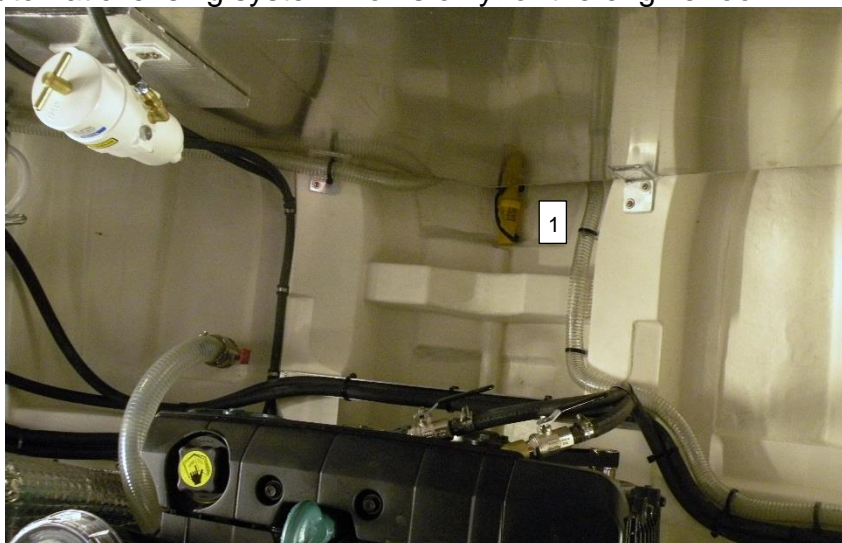

Picture 21: The automatic lensing system in the engine room (1)



MAREX 320 Aft Cabin Cruiser

- The automatic lensing pumps is connected to switches on the dashboard.



Picture 22: Lensing lamp indicator (1)

- System is operating in automatic mode.
- Press and hold switch to run lensing pump manually
- If pump is working automatically or switch is pressed alarm will sound

Possible faults:

- The automatic fuse placed in the main switch panel must be reset (20 amp) and the red light has stopped illuminating.
- The pump inlet is blocked. This may also happen to a manual pump.



4.6 FRESH WATER SYSTEM

INSTRUCTION MANUAL

- ✓ Read the user manual for the hot water tank and the pressure water pump.
- ✓ Read the user manual for the shower draining pump.

The fresh water system provides hot and cold water. Cold water comes directly from the fresh water tanks, while the hot water is provided with help of the engine heat or electrically with the shore connection. The water is never heated from service batteries.

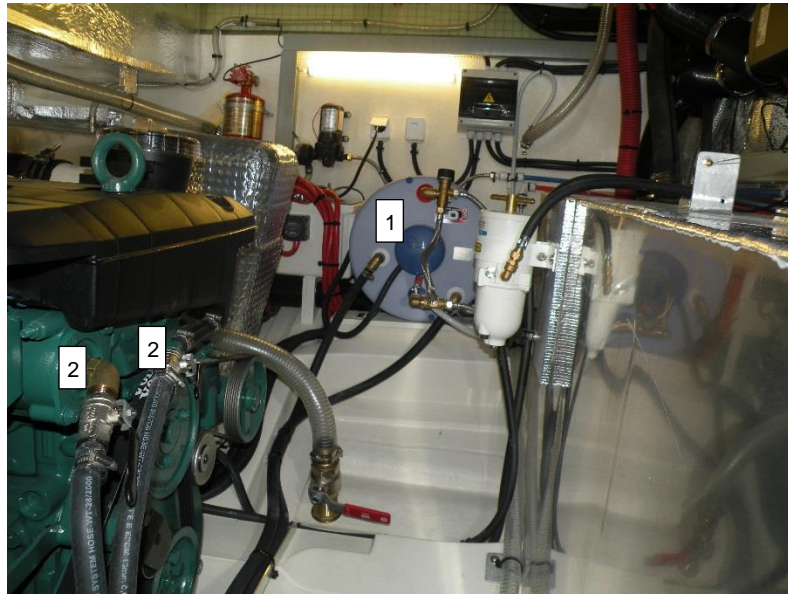

Picture 23: Water heater, placed in the engine room (1), water heater heat exchange connection (2) (Volvo engine)

- ✓ Water heater **MUST NOT** be operated while empty. If this happens, read the instruction manual for the water heater.



Picture 24: Fresh water pump and filter in the engine room (1)



MAREX 320 Aft Cabin Cruiser



Picture 25: Fresh water tank in the engine room – port side (1),
fresh water tank – starboard side (2)

The fresh water system is used for:

- sink and shower in the toilet room
- external shower on the bathing platform
- sink in the pantry
- Windows washer

The system has an own water pump that starts automatically when the pressure falls (by opening a tap).

The shower has a separate lensing pump to drain the water. It is controlled by switch located in shower cabin.



Picture 26: Shower lensing pump (1)



Possible errors that may prevent free flow of water:

- Blocked air ventilation of the water tank.
- Blocked/full freshwater filter.
- Automatic fuse for the freshwater pump has been released. For resetting the fuse see the fuse panel placed starboard at the helmsman position (25 amp), marked "12 V CABIN". The red light is not ON if the fuse is working correctly.
- Micro-switch at the bottom of the sump box is not working correctly.
- Leakage in the system: check all hoses and fittings.
- The shower on aft bathing platform is not closed.

4.7 SEPTIC SYSTEM/BLACK WATER SYSTEM

The system consists of the toilet bowl and the septic tank. It works:

1. By discharging the black water through a bottom valve or
2. with suction hose emptying the tank by a stationary vacuum machine through a filler-fitting at the side-deck on starboard side.

INSTRUCTION MANUAL

- ✓ Read the user manual for the toilet system.



Picture 27: Toilet controls (1), ventilation (2), water level trimmer shaft

When the toilet isn't used, the water level should be 1 cm above the outlet hole in the ceramic bowl. If for any reason more or less water wanted in the ceramic bowl. It can be adjusted by turning shaft trimmer in the rear part of the control panel, accessible through cupboard below sink.

Do not go to bed with a full septic tank. If the sunlight heats a full tank, stinking gas will appear as a result of expansion.



Picture 28: Black water level indicator (1) - optional
(In combination with electrical discharge)

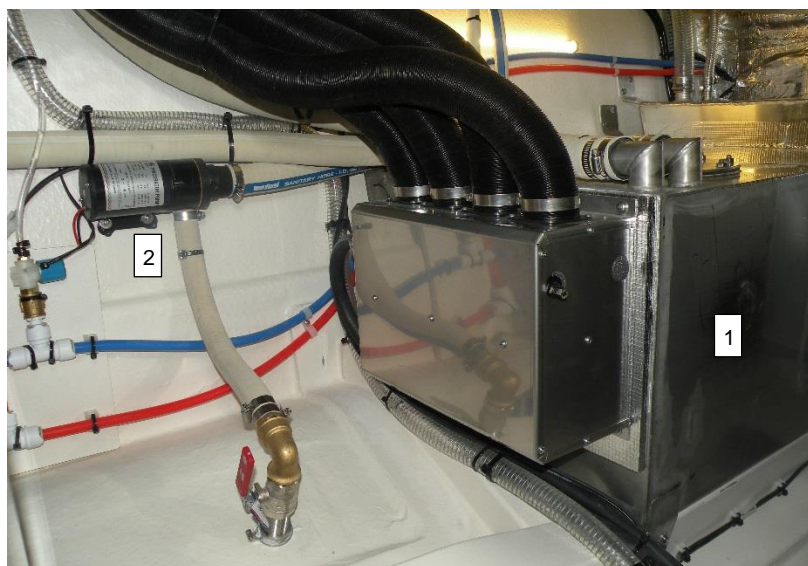

Picture 29: Septic/Black water tank in the engine room (1),
Macerator pump - optional (2)

Possible errors that may stop or block the discharge:

❖ **No water inside the toilet bowl:**

- Blocked inlet for the water into the toilet (plastic pieces, seaweed etc.).
- Filled filter for the toilet pump.
- No power on septic flushing pump. Automatic fuse for the septic pump must be reset. It is located in the fuse panel on the starboard side (25 A), marked "TOILET". The red light in the panel will be ON if the circuit is broken.
- No power to the toilet. The fuse has to be reset.



Blocked macerator in the toilet bowl:

- Due to a block in the hoses.
- Through use of too much or bad toilet paper.
 - Tip:
 1. Fill a plastic bottle (1.5 l) with a strong mix of dish washer detergent and water. Place the bottle upside down into the toilet and squeeze it hard to flush the toilet open.
 2. Empty a strong mix of dish washer detergent and water into the toilet bowl and let the mix work for some time. Pump in water into the bowl and try to flush.
 3. Demount the engine in the macerator. Remove the plastic cover, unscrew the four screws and clean. Caution: Make sure to place the rubber Simmering/Seal in the correct place, or the toilet will leak.

❖ **Blocked air vents can prevent the emptying of the toilet tank and cause bad smell:**

- Tip:
 1. Flush some water into the air vents from the outside of the boat and into the tank. The septic can be dried up and become “composted”.
 2. Fill the septic tank with freshwater and sanitary liquid through the septic tank vacuum inlet on the deck (the fitting).

❖ **Discharge through the hull fitting/valve is not working correctly (macerator pump in engine room):**

- No power on the macerator pump. Reset the fuse in the fuse panel (25 A), marked “TOILET”.
- Macerator pump blocked by non-dissolved paper or non-dissolved septic.
 - Tip:
 1. Close the bottom valve.
 2. Demount the front of the macerator pump. Clean the plastic “fins” mounted before the pump.



4.8 ELECTRIC SYSTEM

The system consists of two main parts:

- 12 Volt Direct Current (DC) from the service batteries
- 230 Volt Alternating Current (AC) by the use of shore power. Be aware that you do not have unlimited power capacity. Use the power carefully and turn off the light in unused rooms.

Voltage: 12V DC/230V AC
Starter battery: 95Ah (Service switch marked "START")
Service batteries: 3x90Ah (Service switch marked "SERVICE")
Battery charger: 230V AC

(Optional: AGM battery – starter battery 1x92 Ah, service batteries 4x92 Ah)



Picture 30: Starter battery (1)
Service batteries (2) – Optional 4 items
(Standard: 1 starter and 3 service sulphuric acid batteries)
Battery charger (3)
Dual sense charging relay (4)



MAREX 320 Aft Cabin Cruiser

INSTRUCTION MANUAL

Read the instruction manual for the battery charger.

12 VOLT SYSTEM:

Batteries:

- *The Starter battery serves for:*
 - Starting of the engine
 - Electronics of the engine
- *The Service batteries serve for:*
 - pumps
 - electronic equipment
 - cabin lights and courtesy lights
 - anchor winches
 - radio and TV
 - various service devices
 - bow thruster
 - aft thruster

INSTRUCTION MANUAL

See enclosed drawings of the switch panel and main switches.

230 VOLT SYSTEM:

- ✓ Using shore power service batteries are recharged first, then through charging relay starter battery is charged
- ✓ The main circuit breaker for the 230V system is 20A. It is placed on the port side in engine room in the main fuses panel.



Picture 31: 230 V Main fuse 20A and grounding relay (1)
(Lamp indicates when 230 V is active.)



4.9 EXHAUST SYSTEM

It consists of standard wet exhaust hose system with a 23 litres water lock. The exhaust hose is going from the engine to the bathing platform on portside, under the aft cabin bed.



Picture 32: The exhaust hose (1), water lock muffler (2)



Picture 33: The exhaust hose is going out under the bathing platform (1)



4.10 VENTILATION SYSTEM FOR THE ENGINE

The engine room is ventilated through the side openings on the hull in the midship area, on port and starboard side. The air travels down the sides and into the engine room.

Do not block the ventilation area when the engine is running!

4.11 FIRE EXTINGUISHING SYSTEM

It consists of:

- 1 portable fire extinguisher that is located inside the trash closet in the pantry.

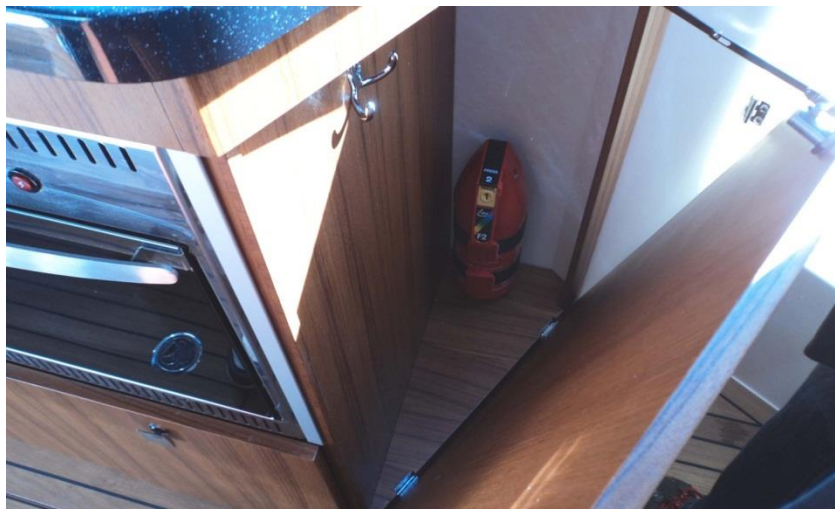

Picture 34: Portable fire extinguisher - 2 kg capacity (1)

- 1 automatic extinguisher in the engine room with an indicator by the helmsman position.



Picture 35: Automatic fire extinguisher in the engine room – 2.5 kg capacity (1), fire extinguisher volume level (2)

- 1 fire blanket near the under sitting group in cockpit



MAREX 320 Aft Cabin Cruiser



Picture 36: Fire blanket (1),
Simple tool set for maintenance (2),
User documentation bag (3)

Fire blanket together with other items for the boat's upkeep are placed under sitting group in cockpit then the boat is delivered for the first time.

⚠ WARNING:

It is owner's responsibility to place fire blanket to comfortable and well-known position for all crew/passengers for quick access in case of emergency



5.0 OPERATION

This chapter contains information advices and hints about practical use of the boat and equipment.

The following of activities and equipment will be commented:

- ✓ Starting the engine
- ✓ Batteries
- ✓ Switch panel
- ✓ Fuse panel
- ✓ Windscreen wipers
- ✓ Electric system
- ✓ Septic system
- ✓ Operation of the equipment in the boat
- ✓ Manoeuvring
- ✓ Hints advices and tips

The following descriptions have two intentions: to promote maximum safety and to guide you through the correct use. This will lead to long unproblematic use and good second hand value of the boat. Proper operated equipment provides safety and comfort aboard.

⚠ DANGER:

Before starting it is important to assure yourself that the safety equipment (safety vests, fire extinguisher, anchor, ropes etc.) is present and functional. Always use a safety vest aboard.

5.1 STARTING OF THE ENGINE

📖 INSTRUCTION MANUAL

Follow the advices of the engine supplier on starting, driving and stopping of the engine.

Before starting check the following:

- ✓ Control the boat for leakages over and under the waterline.
- ✓ Check that all hoses and couplings are intact.
- ✓ Turn on the main switch.
- ✓ Follow the engine's user manual.

⚠ DANGER:

Check if the bathing ladder is felt in and not in the water. An open bathing ladder can damage the propeller.

The throttle (gas/gear regulator) must be in neutral position. For safety reasons the engine will not start in gear.



Picture 37: The neutral position

⚠ CAUTION

NEVER leave ignition ON. Leaving the ignition on without the engine running will drain “START” battery.

5.2 BATTERIES (LEAD ACCUMULATORS)

❖ Generally

Batteries are your source of energy to start the engine and to supply you with services like lanterns, lights 12 Volt system etc.

Your boat is equipped with 4 batteries. One is for starting of the engine and 3 are for services (optional: 5 batteries; 1 for starting and 4 for services). They are located in the engine room.

To make sure that you have enough power to start the boat, there is a starter battery which is separated from the service batteries. If the service batteries are empty, you will still have power to start the engine from the starter battery.

If the start battery is empty, service batteries could be used to start the engine. Start and service batteries can be connected together using a crossover switch in the engine room. Switch should be used only in emergency situations and must be switched off after the engine starts.



Picture 38: Batteries crossover switch (1).

When the engine is running, the starter battery is charged by the alternator. It is important to regularly check and maintain this system.

❖ Charging voltage

The voltage by maximal charging is normally around 14.2 to 14.4 V.

During charging the voltage will rise on the batteries. The battery charger automatically decides when the charging is stopped.

❖ Battery voltage

The voltage on a normal battery is around 12.3 to 12.8 V (if it is unused).

Note: To get the correct voltage when measuring it, you must measure directly on the batteries and not on the generator.

The service batteries and the starting battery have a voltmeter located in the fuse box by the helmsman position. If the voltage drops under 11.5 Volts, they can be permanently damaged.

Please note that LEAD ACID batteries will create gas at 14.4 Volt. This gas is very explosive.

Hint:

- The gas smells like “rotten eggs”.
- Be aware of bad smell and act quickly if gas is created.

If the battery charger is operational and well maintained, it will automatically stop charging before gas is created.

⚠ CAUTION

NEVER turn off the main switch during the engine operation.



5.3 FUSE PANEL & CONNECTION SCHEMES

Fuse panel is placed at starboard side at the helm position/driver's seat.



Picture 39: The fuse panel

Drawings are enclosed in divider number 4.

5.4 MAIN SWITCH PANEL

It is placed at starboard side at the helm position/driver's seat.



Picture 40: Main switches (1)



5.5 WINDSCREEN WIPERS

Control switches are placed on the dashboard below the navigation.



Picture 41: Windscreen washer (1), windscreen wipers (2).

5.6 DASHBOARD INSTRUMENTS INSTALLATION ACCESS

All dashboard instruments can be reached from the underside, by removing of the wall panels, located in the toilet room.



5.7 ELECTRIC SYSTEM

Service outlets 230 Volt in the boat:

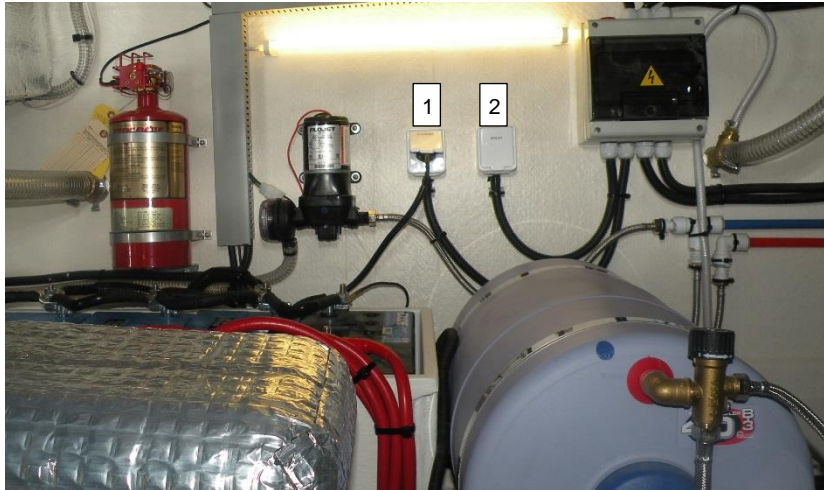

Picture 42: Two 230 V sockets on port side in the engine room, charger (1), boiler (2)



Picture 43: 230 V socket by the pantry - optional (1)



Picture 44: 230 V socket in the toilet room (1)



MAREX 320 Aft Cabin Cruiser



Picture 45: 230 V socket in the front cabin near the main closet (1)

Do not use power unnecessarily and be careful when maintaining the system. Do not forget to check if the connections and joints are properly fastened.

When 230 Volt shore connection is plugged in, the red LED light is on.



Picture 46: The shore connection (1)

From shore power service batteries are charged first and then they reach nominal voltage, dual sense relay switch on and starter battery is charged
Engine alternator charges starter battery first and only then dual sense relay switches on to charge service batteries
Otherwise batteries groups are separated at all times



5.8 SEPTIC SYSTEM

INSTRUCTION MANUAL

The bottom valve of the water inlet must be opened for the toilet to work. Closing valve and the filter are located in the engine room.



Picture 47: Operating of the toilet (1)

CAUTION

After every usage, the toilet is flushed into the septic tank. When the tank is full, further flushing will lead to over pressure and leakage of the system.

DISCHARGE OF THE SEPTIC TANK BY THE DECK FITTING:

The bottom valve **MUST** be closed before the septic is sucked up with a hose. **Water can be sucked up into the tank if the valve is not closed.**

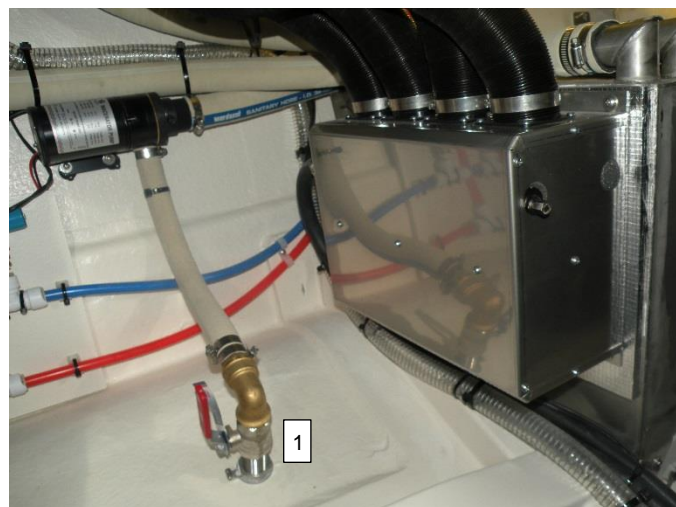

Picture 48: Bottom valve "open" (1)



MAREX 320 Aft Cabin Cruiser



Picture 49: Location of deck discharge (1)

➤ **DISCHARGE OF THE SEPTIC TANK INTO THE SEA (through the bottom valve)** is possible with **the macerator pump**. The macerator pump is controlled with a switch at the dashboard marked “WASTE”. On some models there is a red light that ignites when the pump is activated.

⚠ CAUTION

Observe the discharging process until the tank is empty. The black water/septic instrument shows the level of the tank.

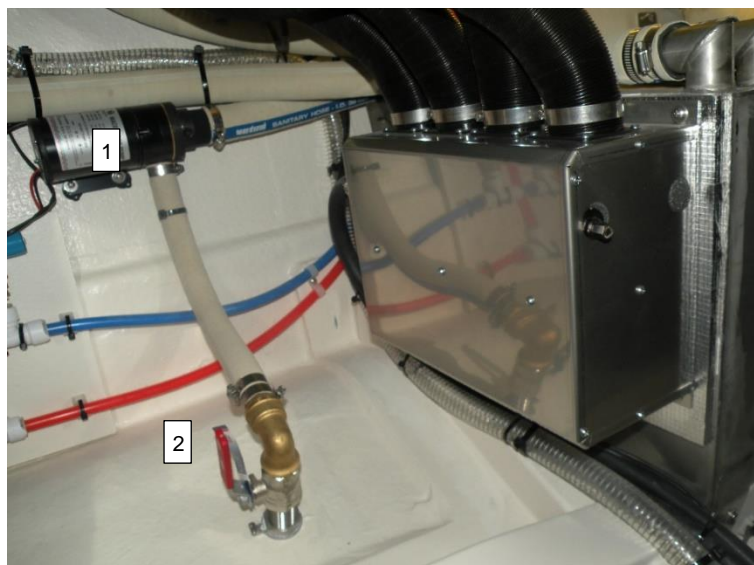

Picture 51: The macerator pump (1),
Septic shut off valve (2)



MAREX 320 Aft Cabin Cruiser

❖ Hints for emptying of the black water tank:

1. *Stop the engine.*
2. *Open the engine room hatch.*
3. *Open the bottom valve. (Picture 51: valve (2))*
4. *Discharge the tank.*

Tip: The sound of the macerator pump is “higher” when the tank is empty.

5. *Stop discharging.*
6. *Close the bottom valve. (Picture 51: valve (2))*

- Empty the septic tank on deep waters far away from land. Avoid polluting and respect local regulation on discharge.
- Always use approved sanitary liquids in the toilet and follow the producer's advice.
- Always use toilet paper that dissolves in water. Normal kitchen paper **MUST NOT** be used in the toilet.
- Never place tampons, pads or cotton into the toilet.
- Inform your passengers and guests.



5.9 OPERATING OTHER EQUIPMENT

5.9.1 COOKER AND OVEN

INSTRUCTION MANUAL

See user manual of cooker and oven.

WARNING:

The cooker uses oxygen! Provide good ventilation when the device is in use. Avoid suffocation. Do not use for heating! Do not let a fender block the exhaust outlet (in the hull) as this can cause fire.

5.9.2 DEFROSTER

The defroster is driven by the engine's heat and it is operated by the switch on the dashboard. It has two speeds and the outlets are in front of the dashboard, under the windscreen.



Picture 52: Defroster location in the engine room (1)



5.9.3 DIESEL HEATER

INSTRUCTION MANUAL

See the diesel heater's user manual.

The diesel heater is placed in the engine room.

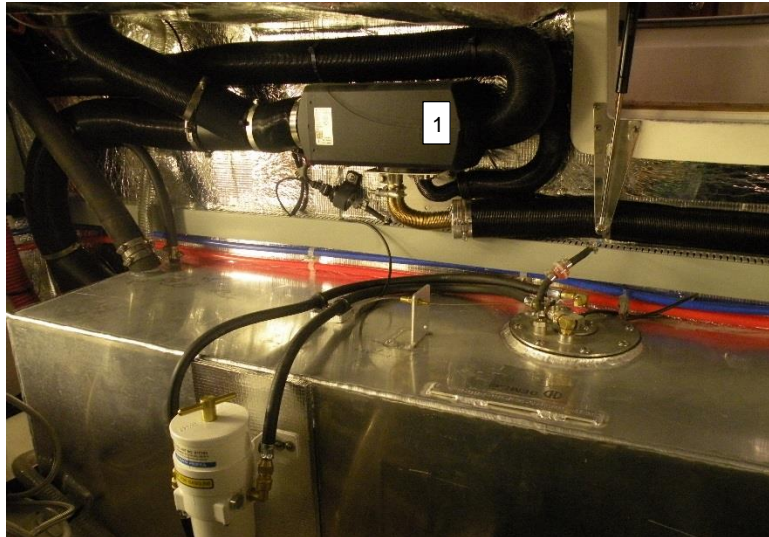

Picture 53: Diesel heater with blower (1)



Picture 54: The heater switch (1)

The heater outlets:

- ✓ 1 in the salon
- ✓ 1 in toilet room
- ✓ 1 in the front cabin
- ✓ 1 in the aft cabin



⚠ CAUTION

Never close the heater outlet in the cockpit. This can cause overheating and fire. Avoid contact of materials with the heater outlets. Do not block the heater outlets with any objects.

5.10 MANOEUVRING OF THE BOAT

Manoeuvring of a boat, designed for category B

Important factors to understand and study are: the boat, the cargo weight and placement, position of the rudder, the position of the trim flaps. The use of trim flaps and the rudder takes time to master. Spend time on practicing this.

Start immediately to practice how to manoeuvre the boat with and without the bow propeller. We recommend to practice towards a buoy or another fixed point. Do not underestimate the impact of side winds.

Observe the aft wave and pay attention to the wave you create. The waves can be a danger to others and a large wave is a sign of very high fuel consumption. Large waves are very unpopular.



MAREX 320 Aft Cabin Cruiser

❖ **MANOEUVRING IN ROUGH SEAS**

Never enter rough sea unless you are absolutely positive that the boat and crew/passengers can handle it.

- Be well prepared.
- Fasten loose equipment and luggage.
- Have the emergency equipment ready.
- Close all hatches and portlights.
- Close all sliding doors.

⚠ **WARNING:**

Do not let children stay on open deck when sailing on rough seas. The anti-skid coating can be slippery when wet.

❖ **AGAINST THE WAVES**

- Adjust the speed according to the height of the waves.
- Adjust the angle towards the waves.
- Avoid waves hitting the boat sideways.



Picture 55: Sailing against the waves

❖ **MANOEUVRING WITH THE WAVES**

- Trim the bow high up with the tilt and trim flaps.
- Avoid sailing faster than the waves.
- Throw an emergency anchor/drift anchor if the speed is too high.

⚠ **WARNING:**

- **Manoeuvring possibilities are limited at high speed!**
- **Sudden manoeuvres at high speed can cause loss of control.**
- **Reduce speed before sharp turns.**



MAREX 320 Aft Cabin Cruiser



Picture 56: Manoeuvring with the waves

⚠ WARNING:

Do not sit at the bow area when the boat is moving fast.

Do not sail the boat at maximum speed in trafficked areas or in weather conditions that can reduce the visibility. Reduce speed according to other boaters as safety precaution for you and others. Observe the speed limit and non-wave zones inside marinas etc.

The visibility can be reduced by a high trim angle as well as:

- The cargo and the cargo placement
- Speed
- Quick acceleration
- Entering and exiting planning
- Sea conditions
- Rain and sea spray
- The boat's own light
- Position of the boat helms equipment and curtains

Knowledge about weather conditions:

- Show respect for the weather and the wind conditions.
 - Observe the conditions and listen to local advices.
 - Always listen to the weather forecasts.
 - Always check the fuel level before any trip. By low fuel level in high seas the engine can suck air and this can cause the engine to stop.
- Always keep enough distance to avoid collisions and to manoeuvre away in case of unexpected happenings.
 - Adjust the speed according to all passengers comfort. The comfort is normally perceived better for the helmsman than the passengers. Be aware of this and take care of the passengers comfort.



MAREX 320 Aft Cabin Cruiser

- Always keep the engine room closed when starting the engine.
- Do not stay at the fore deck, bathing platform or side decks during sailing.
- Close all hatches as well as the hardtop or canopy.
- Close the aft cabin door before sailing.
- Never use the bathing ladder as long as the engine is running.
- Check that the navigation lamps are working, before sailing in the dark, and always keep spare bulbs in the boat.

5.11 HINTS AND ADVICES

5.11.1 LIFTING AND STORAGE IN A “CRADLE”

Adjust the lifting straps so that the boat is lifted in a horizontal position. Use protection between the straps and the boat.

Place of the lifting straps:

- ✓ Like shown on the figure 17.

Placing the “cradle”:

- ✓ Near the lifting straps.

Placing of the support for storage:

- ✓ Like shown on the figure 18.

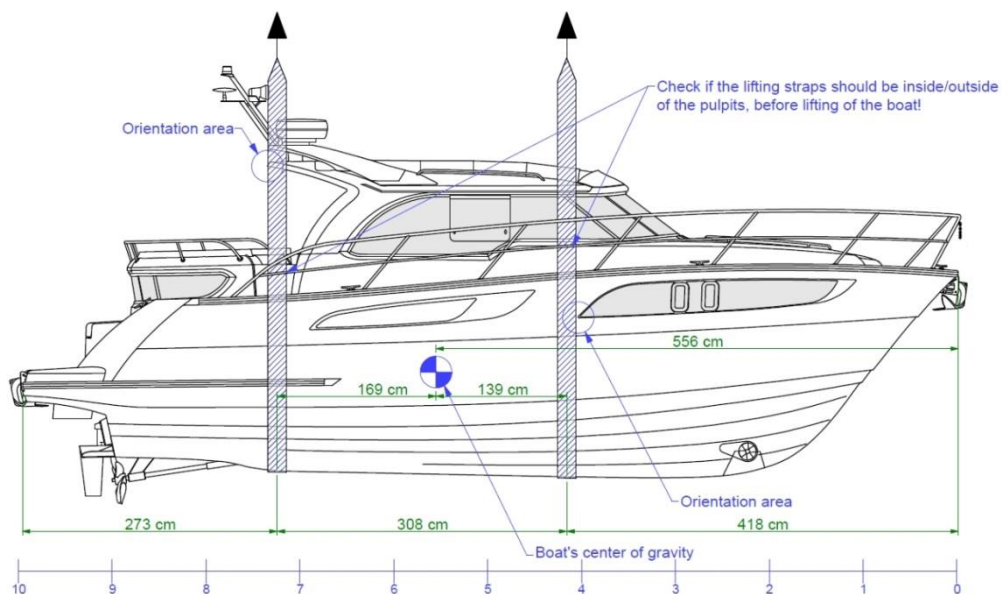

Figure 17: Place of the lifting straps

⚠ WARNING:
DO NOT STAND UNDER THE BOAT WHEN IT IS LIFTED!



MAREX 320 Aft Cabin Cruiser

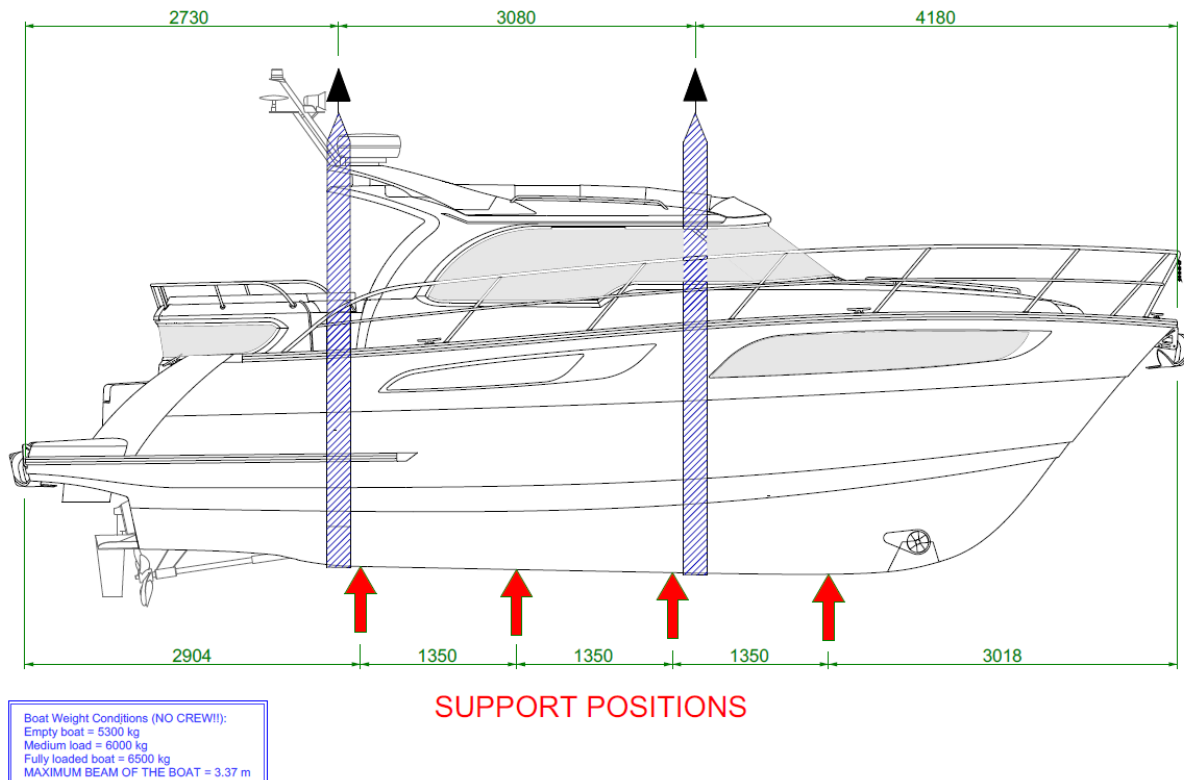

Figure 18: Place of the storage support

5.11.2 BOAT TRANSPORT

- When the boat is transported on a trailer, the weight of the boat must rest on a surface on the bottom “keel”.
- Adjust the side support to avoid dislocation and fasten the boat safely.
- Make sure there is no cargo in the boat.

⚠ WARNING:

Use a trailer suitable for the boat and its mass.

5.11.3 BOAT MOORING

Marex 320 Aft Cabin Cruiser has 2 pullers in the front, 2 at the back/aft of the boat and 2 pullers at the mid-ship area.

5.11.4 BOAT ANCHORING

There are two possible “strong points” at the front and/or aft anchor (depends on boat version).

- Recommended anchor weight is 15-25 kg.



MAREX 320 Aft Cabin Cruiser

- Recommended anchor rope diameter is 14-16 mm and length approx. 30-50 meters.

5.11.5 TOWING AND BEING TOWED

You can tow another boat or being towed. Consider that your boat has two “strong points” in the front and two “strong points” at the back (on each side of the boat are two pullers).

⚠ CAUTION

Always tow or be towed at a slow speed. Never exceed the hull speed of a displacement craft when being towed.

A tow line shall always be made fast in such a way that it can be released when under load.



6.0 PERIODIC MAINTENANCE

The maintenance of the boat and equipment should be performed by authorized personnel.

6.1 MAINTENANCE OF THE HULL

6.1.1 BEFORE PLACING THE BOAT ON WATER

Your boat is exposed to sun, wind and water. Over time this will make the gelcoat mat. It is therefore important to wax the boat before it is placed on water. You may wax more than once per season.

If the boat has scratches or other damages in the gelcoat, those damages should be repaired. It is important that the correct gelcoat is used for this repair. This job is complicated and we recommend you to use a specialist for the best result.

If the boat gets yellow spots this can be form-wax from the production of the boat and is very common and difficult to avoid. This wax can be removed in warm weather with a thinner and very hot water.

To protect the hull and to prevent osmosis, Marex recommends priming the hull under the waterline before antifouling is added. This has already been made if antifouling has been ordered as extra equipment.

- ✓ Sand the underwater surface with sandpaper grade 400.
- ✓ Clean the surface and dry.
- ✓ Apply 2 layers of 2-component epoxy primer or similar product according to the producer's specification.
- ✓ Apply antifouling.
- ✓ Do not paint on the Zinc anodes.

CAUTION

Use a different antifouling on the propulsion components, intended for this purpose.

6.1.2 BEFORE WINTER STORAGE

Clean the boat thoroughly after lifting it out of the water. Remove all fouling and apply a thin layer of wax or Vaseline over the boat. This will ease the maintenance next year. Spray all electrical contacts with anticorrosion spray, suitable for electrical equipment.



6.1.3 NORMAL MAINTENANCE

Remember that a well-kept boat has a higher second hand value. Oil and grease can leave permanent stains. If you need to rub and polish the boat it is important to wax it.

6.2 MAINTENANCE OF THE TEAK DECK

The deck supplier recommends that the boat owner tests and uses those products that give the best result. The wood must first be well cleaned with soap and water. Do not use a hard brush. Do not use high pressured water. The wood must be totally dry before fat/grease/oil is applied. This will give the teak its colour but many boaters prefer the teak to go grey.

The deck should never be exposed to acid-based detergents. Acid-based detergents will damage teak seams irreparably.

There are many products on the market and Marex recommends oiling the deck with oil without chemical additives. To get the best result the teak can be sanded with fine sandpaper and then oiled.

6.3 MAINTENANCE OF THE ENGINE AND THE DRIVE

INSTRUCTION MANUAL

Read the engine's user manual!

- Control the oil level on engine and gearbox often.
Control the through hull shaft connection and its oil level.
- Control the seawater filter every 25 engine hours.
- Ensure that the flow of cooling water is continuous.
- For periodic control and replacements see the engine manual.
- Control the fuel system for visual leakage.
- Regularly check that boat fuel line connectors are tight.

6.4 MAINTENANCE OF THE STEERING SYSTEM

- Control the couplings, hoses, bearings and fastening points.
- Control the fluid level in the steering system frequently. Check the cylinders and hoses for leakages. Lubricate the joints and couplings with the prescribed grease/oil.
- In case of leakage, contact the supplier.



6.5 MAINTENANCE AND CONTROLLING OF THE ELECTRIC SYSTEM

⚠ DANGER:

When the boat is connected to the shore power, the ZINC anodes must be controlled often (visible on the propeller nut). If the anodes are damaged or filled with “holes” there can be something wrong with the shore power system or the marina electric system or any other near boat or a close electrical system. Disconnect immediately and do not connect until the source is found.

⚠ DANGER:

- **Clean the battery surfaces on a regular basis to prevent short - circuits.**
- Check if the ventilation holes are open, so that gas can exit. (Starter battery or service batteries are “gel” batteries and need no ventilation.)
- The battery poles and the cable shoes must also be kept clean and greased with acid free fat / Vaseline to prevent corrosion.

Fluid level in the cells (does not apply to GEL batteries):

Control the levels by opening the plugs on the batteries. It should be at least 5 mm over the plates. If the level is too low, fill it up with distilled water. Do not use water from the tap. It contains minerals or pollution and can harm the batteries.

⚠ DANGER:

Do not use open fire when you control the liquid level. The gas that develops during recharge is explosive. You can smell it. It smells like “rotten eggs”. Do not use open fire if you smell something strange or similar to this, until the cause is known or found.

Possible errors:

See enclosed user manual from the battery supplier.



6.6 MAINTENANCE OF THE GAS SYSTEM

INSTRUCTION MANUAL

Read the gas system's user manual.

- Test the gas system for leakages at a regular basis. Check all connections by:
 - Testing and observing the bubble-leakage-tester in the compartment on the bathing platform.
 - Manually test the system by adding soap and water to valves. Make sure the cooker valve is closed and the gas bottle valve is open. Look for bubbles.

DANGER:

If you discover any leakage, close the system and immediately release the gas bottle valve (the pressure reduction valve) and make sure an authorized person repairs the system before you use it further.

- The pressure reduction valve must be controlled often and should be replaced every year.



Picture 57: Gas bottle - the pressure reduction valve (1), the test button (2)

- Gas system hoses must be controlled at a regular basis minimum once per year. Change immediately if any hose is damaged or worn out.



6.7 MAINTENANCE OF THE FUEL SYSTEM

- Regularly check fuel filters in the fuel tank and clean or replace if necessary.
 - Disconnect all hoses from fuel tank hatch.
 - Unscrew hatch nuts.
 - Carefully take out hatch with filters.
 - To clean filters, we do recommend acetone, white spirit or special cleaners like carburetor cleaner or etc.



Picture 58: Fuel filters in fuel tank.



6.8 MAINTENANCE OF THE LENSING SYSTEM

INSTRUCTION MANUAL

- SAFETY PRECAUTION – Check the function of all lens pumps at regular intervals. **Pump inlets have to be clear from debris and garbage.** If seacocks are fitted in the fore and aft peak bulkheads, they shall be kept closed and shall only be opened to let water drain into the main bilges.



Picture 59: Pump inlet in the engine room (1)

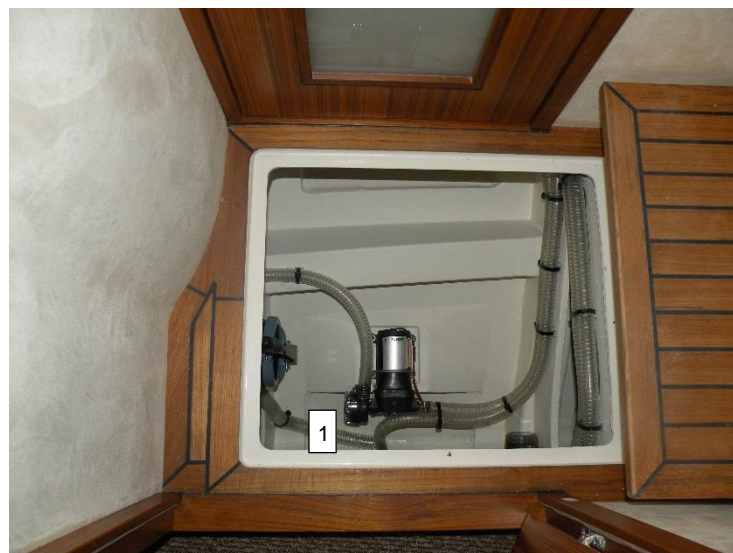

Picture 60: Pump inlet in the front cabin area (1)



6.9 MAINTENANCE OF THE FIRE EXTINGUISHERS

INSTRUCTION MANUAL

Read fire extinguishers' user manual.

- Always check that the pressure is correct at the manometer. The indicator must be in the green zone. Contact a professional for maintenance.
- All fire extinguishers must be controlled one time per year by qualified personnel.

6.10 MAINTENANCE OF THE FRESH WATER TANKS

- The fresh water filter should be controlled and cleaned at a regular basis minimum twice per year. A full water filter gives a poor water flow.
- Check periodically for probable calcification of the water system.

CAUTION

The switch in the low end of the shower sump box will be damaged by frozen water. The switch must be controlled and eventually demounted and tapped for water.

- If hot water starts smell bad, water heater anode must be checked. Anode is used to prevent water heater tank from corrosion and must be checked regularly. It can be found inside the water heater tank near the heating element. Anode can be checked visually and if it looks very corroded when removed, must be changed. Also, must be noted that only hot water smells bad when the anode is bad.

6.11 MAINTENANCE OF THE FENDER LIST

- The fender list should never be exposed to acetone or other similar solvents. To clean vinyl surfaces, like rubbing strakes, fenders etc., we do recommend abrasive cleaners for maritime use.



7.0 PREPARING FOR THE SEASON

7.1 GENERAL PREPARATION

- ✓ Take off the canopy in due time and ventilate the boat thoroughly before the boat is placed on water. Wash and polish the boat. Apply antifouling under the waterline.
- ✓ Replace the batteries and refill the water level. Check/measure the capacities, cables and cable shoes. Check the hoses and other joints. Control that the instruments and navigation lights are functioning.
- ✓ Check that all valves in the hull are working and that the hoses are properly fastened.
- ✓ Check that all filters are airtight:
 - fresh water filter
 - shower pump filter
 - toilet water inlet
- ✓ Close all draining plugs. Check that bottom valves for seawater cooling is open. Check that pipes and water taps are closed.

Adjustments on the engine feet/fundaments must only be performed by authorized personnel. The bolts are glued to the fundaments. By any adjustments you will damage the glue. If the feet/bolts are loose, contact a serviceman immediately.

CAUTION

Check for potential frost damages.

7.2 PREPARING THE ENGINE AND THE DRIVE

- ✓ Control the new oil level (the oil must be changed). See the engine's user manual.
- ✓ Control the gearbox's new oil level (the oil must be changed). See the engine's user manual.
- ✓ Control the fuel filter and change it if necessary. Control the fuel system and fasten all couplings and fittings. Check the water separator. Look for any damages or leakages or potential hazard. See the engine's user manual.
- ✓ Check the through hull fitting at the shaft. Control all couplings and fittings.
- ✓ Check the propeller, the propeller nut and the splint pin.



7.3 PREPARING THE STEERING

- ✓ Check the steering function before the boat is placed on water.

7.4 OTHER EQUIPMENT

- ✓ Cleaning the canopy: See the supplier's manual in divider number 4.
- ✓ Clean all textiles according to the manuals.

7.5 REMOVING RUST/CORROSION

The only steel usable for boat is acid proof stainless steel AISI 316 L. Bolts, screws and other stainless steel parts are made from A4 quality stainless steel.

Stainless steel is not maintenance free and should be polished together with the boat. Use a soft tissue and a small brush like a toothbrush to remove dust. **DO NOT USE RUBBING materials on stainless steel.**

Rust marks on screw-heads, rails, cleats or especially on anchors are normal. It is not rust or corrosion but discoloration. This comes from mounting tools, dust, iron particles and similar. This discoloration can easily be removed by polishing with "autosol Wurth" or other similar polishing liquids.



8.0 WINTER STORAGE PREPARATION

- If the boat is covered with plastic, it is important to protect all surfaces against rubbing and tearing through the winter. It is a big risk that this will go mat, if it is unprotected. Use masking tape or similar to protect gelcoat, glass and steel.
- Empty the windscreen water system.

8.1 BATTERIES

The batteries can be kept in the boat during the winter, although it is not recommended. If you leave them in the boat then it is important that the batteries are fully charged and maintained during the winter to compensate the self-discharge that will happen. If the batteries are kept in the boat, it is also important to disconnect the PLUS cable (the red one) and prevent contact with electrical cables and the battery cable shoe.

⚠ DANGER:

If the batteries are connected to a maintenance charger that is connected to a grounded outlet, the boat is in big risk of galvanic corrosion due to grounding errors between the boat grounding (z-drive or shaft) and the land grounding.

⚠ CAUTION

To prevent damage to the hot water tank, disconnect the 220V system when the hot water tank is empty. Pull out the plug.

8.2 HULL

- Clean the boat while it is still in the water. Scrub all spots on deck and at the waterline. Use a boat shampoo.
- Control all through hull fittings.
- To save work it is recommended to polish the boat before the winter.
- Clean all dust and dirt to prevent a bad smell the next season.
- Remove all personal belongings to prevent mildew.
- Place 1-2 moist removers that attract moist and condense. Drain these periodically through the storage period.

8.3 STEERING SYSTEM

- See the enclosed steering system supplier's user manual.
- Control all nuts, joints and through hull leads. Look for damages.
- Control all fittings, hoses and bearings.
- Control the steering fluid in the hydraulics system. Refill if necessary.



8.4 SEPTIC SYSTEM

The system should be empty during storage at freezing temperatures.

- Empty the toilet bowl and septic tank/blackwater tank for contents BEFORE lifting the boat out of the water and refill one time with water before emptying again. Fill with mixed anti-freeze.
- Use anti-freeze in the toilet and pump it through (use anti-freeze mixed with water, pure anti-freeze can damage the seals).
- Control all hoses and couplings. Retighten the hose clamps. Keep all valves open.
- Demount all hoses from all filters and pumps.
Drain the filter for the toilet water inlet.

⚠ CAUTION

Always mix anti-freeze with water. Pure anti-freeze will damage the system.

8.5 FRESHWATER SYSTEM

The freshwater system must be completely drained if the boat is exposed to freezing temperature.

- Open all valves including the aft shower.
- Open all taps and run until empty.
- Close the pantry pump when the system only delivers air.
- Let all taps be open during the winter.
- Take off the shower handgrips.
- Empty the water tanks.
- Empty the hot water tank through the opening valve on the tank.
- Demount all hoses from all filters and pumps.
- Drain all filters:
 - fresh water filter
 - filter for the shower pump

⚠ CAUTION

The switch in the low end of the shower sump box will be damaged by frozen water. The switch must be controlled and eventually demounted and tapped for water.

8.6 ENGINE AND DRIVE

- See the enclosed engine's and drive supplier's user manual.



9.0 ENVIRONMENTAL ISSUES

The boat owner is responsible for following local environment laws and to reduce pollution caused by:

- ✓ fuel and oil
 - ✓ garbage
 - ✓ noise
 - ✓ waves
 - ✓ exhaust
 - ✓ septic/black water
 - ✓ chemicals and antifouling
-
- Ensure that bilge water is clean before pumping out.
 - **The risk of pollution from the boat is increased during refuelling, servicing or bilge pumping.** When refuelling, be careful not to overfill the tank. If oil/fuel is spilled, remove it instantly using an absorbent sheet or pad. Always keep a small quantity of oil/fuel absorbent material on the boat for instant use if needed. Never use detergents or emulsifiers to deal with oil/fuel spills.
 - Do not discharge toilets or holding tanks close to shore or in any prohibited zone. Use harbour or marina pump-out facilities to empty the holding tank before leaving the harbour.
 - Be encouraged to use environmentally compatible products in the operation and maintenance of the boat.
 - Prevent and discourage hull cleaning or any other underwater process that is likely to remove anti-fouling or any other deleterious material to the marine environment.
 - Use low or non-phosphate soaps.
 - Wipe cooking utensils and plates clean with a paper towel before washing-up.
 - Collect all your rubbish on board and dispose it properly ashore (including cigarette butts).

Be aware of international regulations against marine pollution (Marpol) and respect them as much as possible.



10.0 POSITIONS OF THROUGH HULL AND DECK FITTINGS

10.1 STARBOARD SIDE

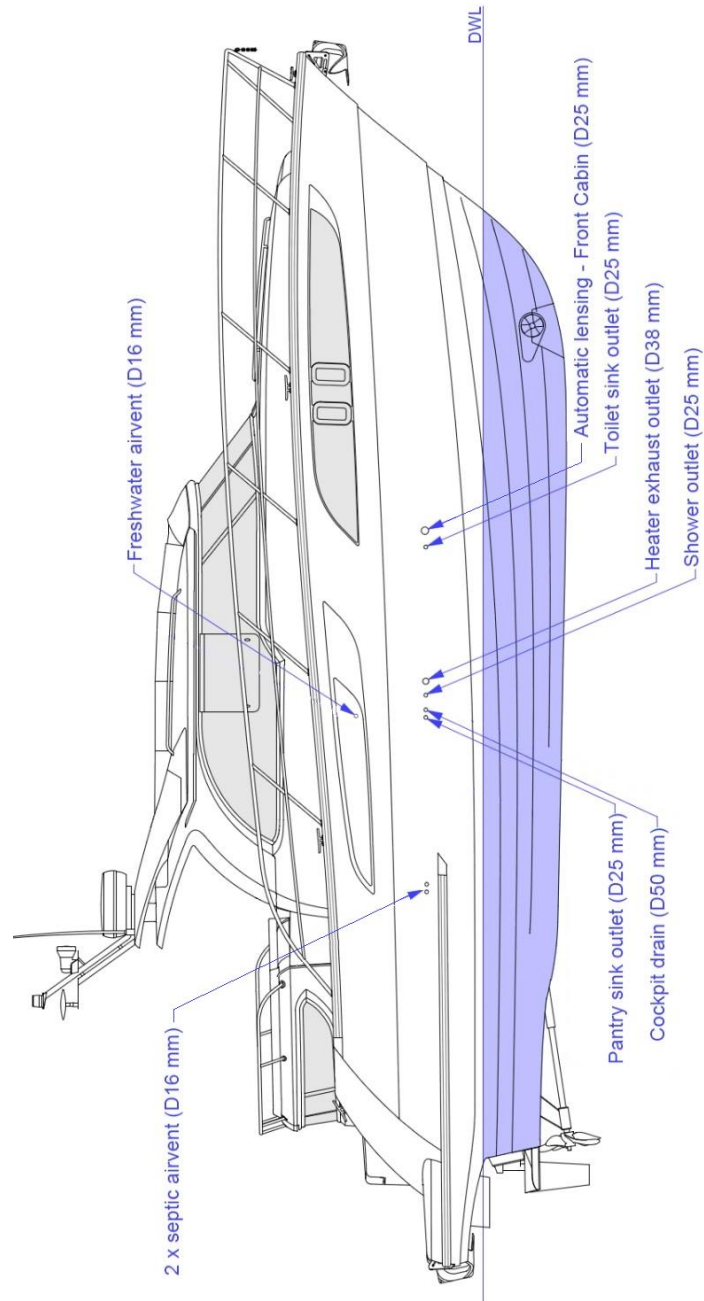

Figure 19: Starboard side.



MAREX 320 Aft Cabin Cruiser

10.2 PORT SIDE

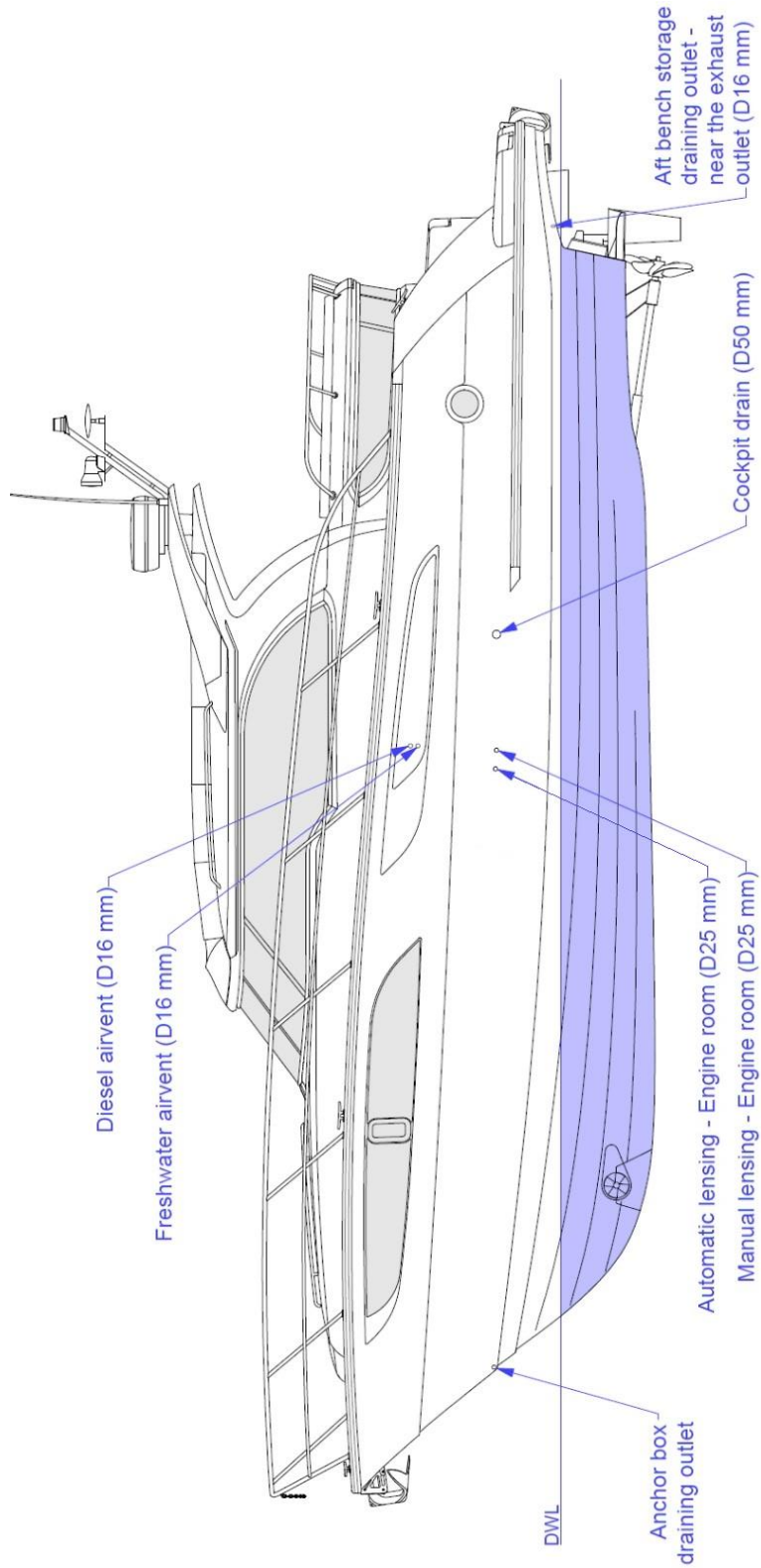

Figure 20: Port side.



10.3 TOP VIEW - HULL BOTTOM

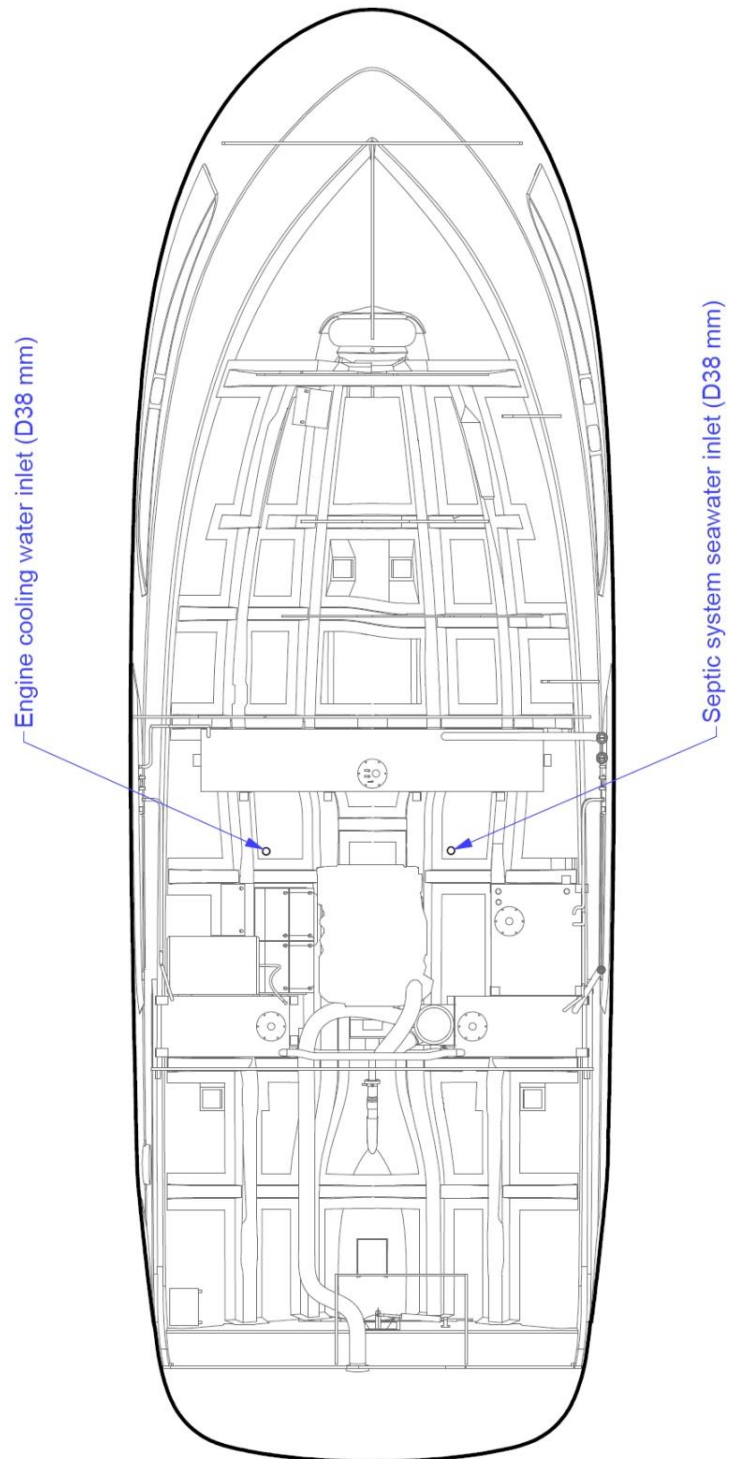

Figure 21: Top view



MAREX 320 Aft Cabin Cruiser

10.4 TOP VIEW – DECK

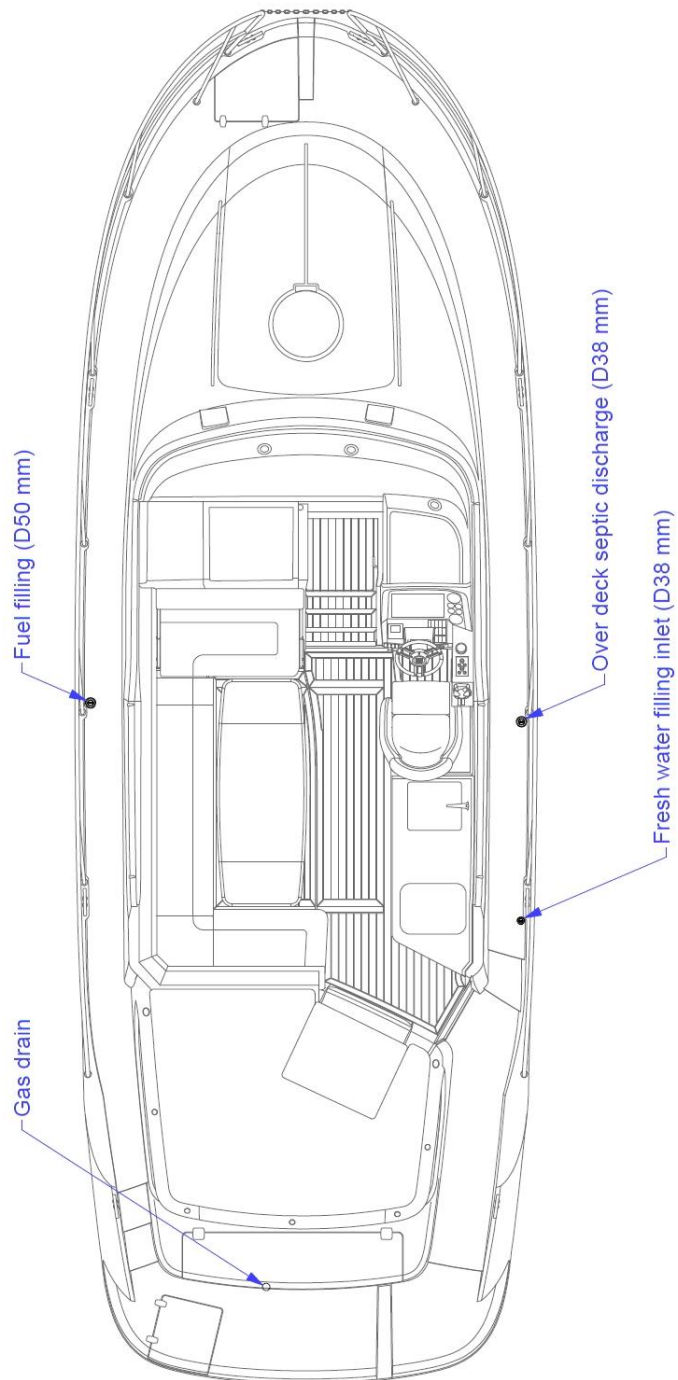



Figure 22: Top view – deck

11.0 OVERVIEW

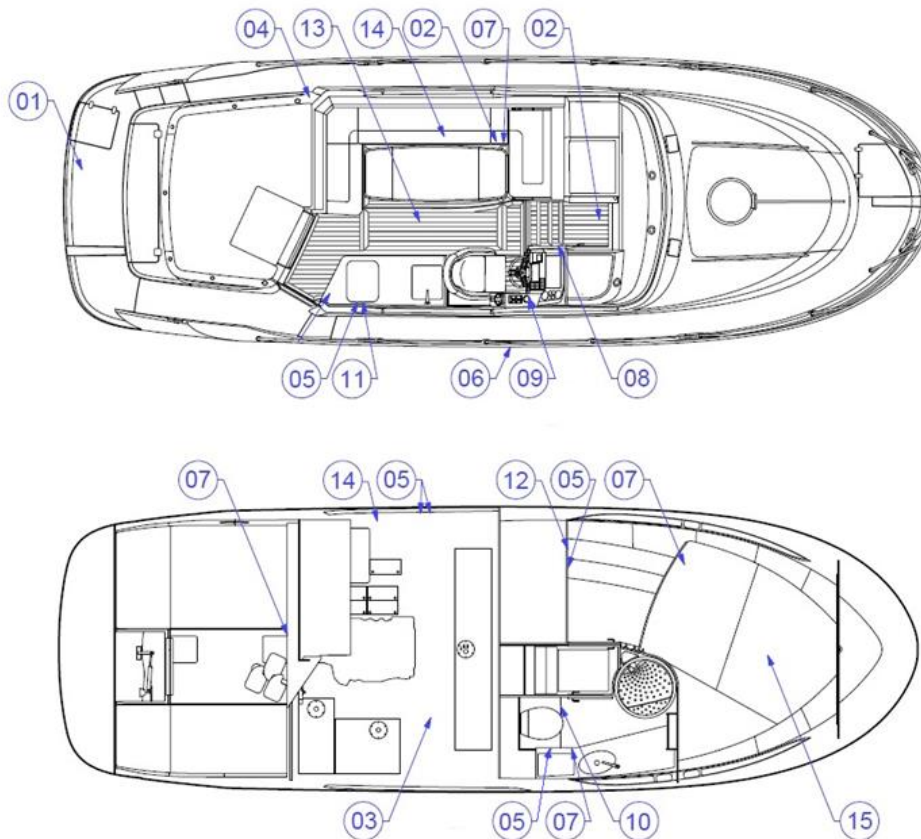

Figure 23: Overview.

1. Draining of water from the aft deck
2. Manual lensing pump
3. Toilet water inlet valve (engine room)
4. Shore connection inlet 230 V
5. 230 V socket
6. Heater exhaust outlet
7. Heater outlet
8. Switch panel for heater
9. Main switch panel
10. Switches for shower and bathroom fan
11. Switches for light dimmer
12. Front cabin light dimmer
13. Engine hatch (access to fuel and septic tank)
14. Fire extinguisher
15. Bow propeller



ANNEX 1: A CHECKLIST OF ALL NECESSARY ACTIONS BEFORE USE

Most boating problems and accidents can be prevented, and it is important to find and correct any issues before you leave mooring. You can make your own checklist, choosing the items from the following list. Keep a copy on the boat and quickly run through the list.

Check the forecast and local wind and wave conditions.	
Tell someone where you are going and when you will be back.	
If you have guests, prepare them: appropriate clothing and gear, seasickness prevention, etc.	
Disconnect and stow away dock power and water lines.	
Smell around the boat for any suspicious fumes.	
Check the engine: fuel and oil.	
Inspect hoses, look for loose wiring, etc.	
Check the bilges for fluids or leaks.	
Open seacock for engine water intake.	
Run the ventilation in engine room.	
Check if there is all safety equipment on board.	
Check fire extinguishers, flares, first-aid kit, etc.	
Check engine cooling water outflow.	
Open other seacocks (head, sinks, etc.).	
Check navigation lights.	
Turn on the VHF and check the forecast again.	
If you have new guests, show them around and talk with them about what to do in an emergency, how to put on safety vests...	
Stow personal items and gear out of the way.	
Tune the VHF to channel 16.	
Turn on and test other electronics: chart plotter, radar, etc.	
If you have guests, make sure they are comfortably seated.	



ANNEX 2: A CHECKLIST OF ALL NECESSARY ACTIONS AFTER THE WINTER STORAGE

You can add your own comments and make a copy for next year.

Wash and polish the boat. Apply antifouling under the waterline.	
Check that all valves in the hull are working and that the hoses are properly fastened.	
Check the through hull fitting at the shaft and its oil level. Control all couplings and fittings.	
Check the engine feet (Adjustments on the engine feet/fundaments must only be performed by authorized personnel!).	
Check the fuel system (fuel fittings and hoses – replace if necessary).	
Control the new oil level (the oil must be changed; creamy brown or gray engine or drive oil has water in it – call a mechanic).	
Control the new gear oil level (the oil must be changed).	
Control the fuel filter and change it if necessary.	
Control the fuel system and fasten all couplings and fittings.	
Check the water separator.	
Check that bottom valves for seawater cooling is open.	
Check/measure the capacities, cables and cable shoes	
Check for potential frost damages: 1. inspect non-metallic through-hulls - they can get brittle and winter ice can crack or loosen them. 2. look for hoses that have been forced off or split from freezing.	
Look for any damages or leakages or potential hazard.	
Close all draining plugs.	
Check that all filters are airtight (freshwater filter, shower pump filter, toilet water inlet).	
Check that pipes and water taps are closed.	
Check the hoses and other joints.	
Replace the batteries and refill the water level.	
Check the propeller, the propeller nut and the splint pin.	
Check the steering function before the boat is placed on water.	
Inspect anchor.	
Take off the canopy and ventilate the boat thoroughly.	
Clean the canopy.	
Clean all textiles according to the manuals.	
Stainless steel is not maintenance free and should be polished together with the boat.	
Control that the instruments and navigation lights are functioning.	



MAREX BATTERY INDICATOR WITH AUTOMATIC DEEP DISCHARGE PROTECTION

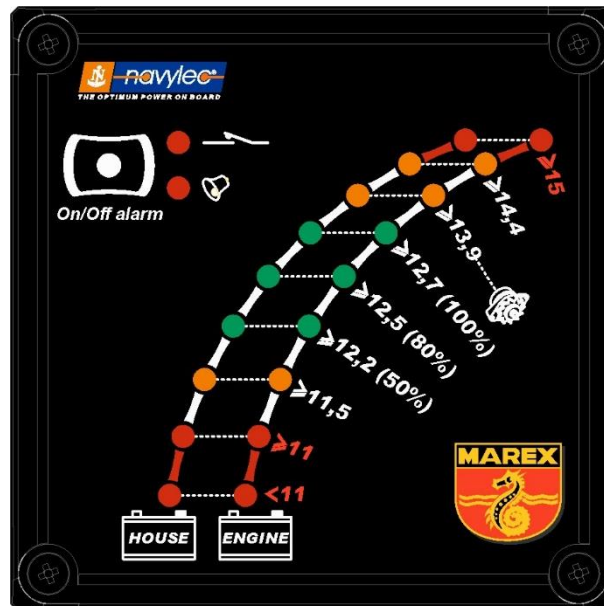

- First group (HOUSE) is service group. Second group (ENGINE) is engine start battery (in case it is twin engine installation – starboard engine battery).
- System is activated by default. Red diode will blink every 30s to indicate that. Protection can be deactivated by pressing and holding “off” button for 3 seconds. When system is deactivated, red diode no longer blinks.
- Battery protection will turn off service batteries if service (HOUSE) battery group voltage fall below 11,5V or get above 15,0V for longer than 200 seconds.
- Engine start batteries are not monitored and will not be shutoff, so engine would not be damage by sudden power loss.
- **We recommend that battery protection left on always. We want to remind that batteries drained to 20% of their capacity (11.85V) and left uncharged for longer periods will permanently damage batteries.**

Notes



MAREX 320 Aft Cabin Cruiser

Notes



MAREX 320 Aft Cabin Cruiser

Notes